

ORNAMENTO NATALIZIO di Luigi Leonardi

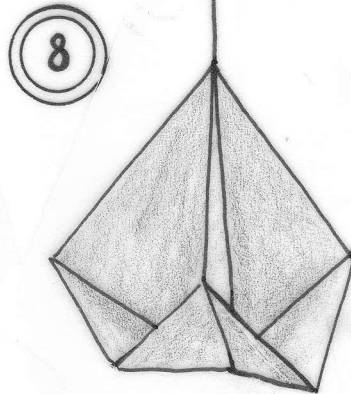

Apparentemente il modello è simile a quello di Jack Skillman pubblicato a pag. 16 di "Origami Christmas Tree Decoration" - monografia n. 20 della British Origami Society, ma la costruzione è completamente diversa e il modello ha la possibilità di diverse e più decorative varianti.

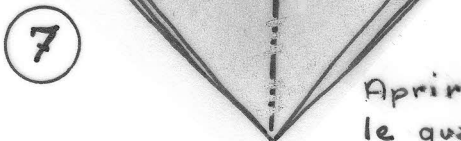
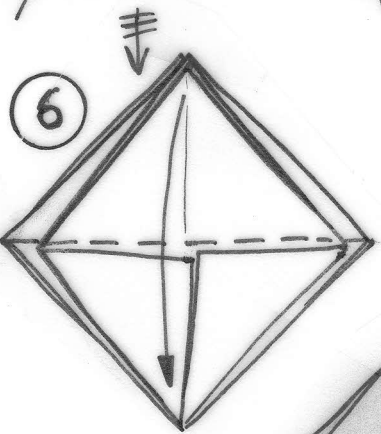
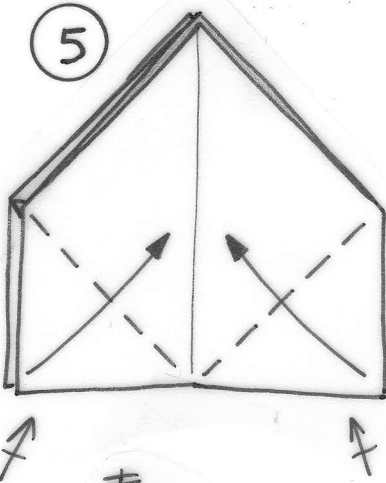
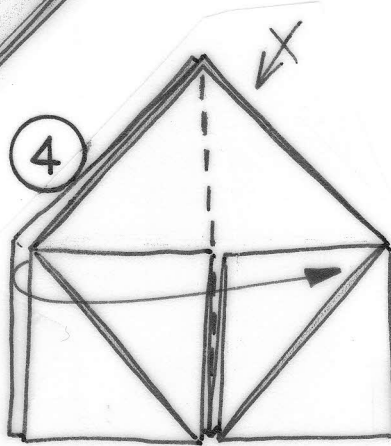
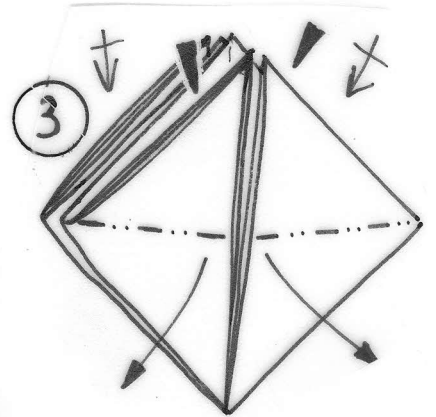
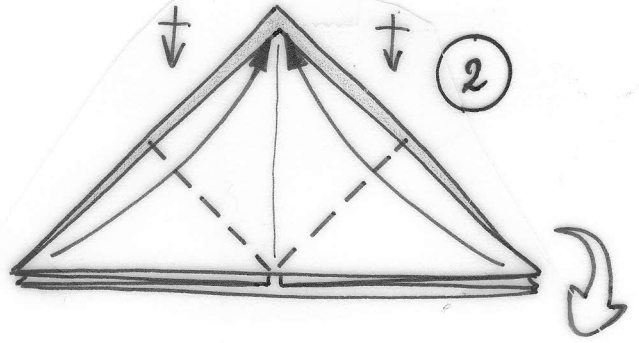
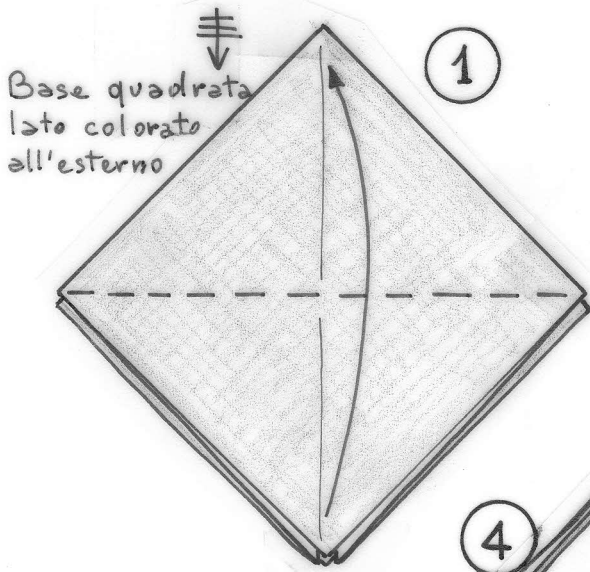

Aprire tutte
le quattro tasche.

LL

ORNAMENTO NATALIZIO

variante n. 1

Iniziare dal punto 6 dell'ornamento natalizio.

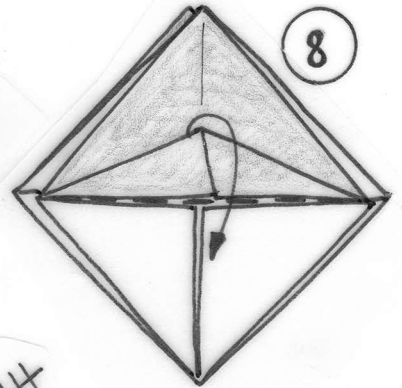
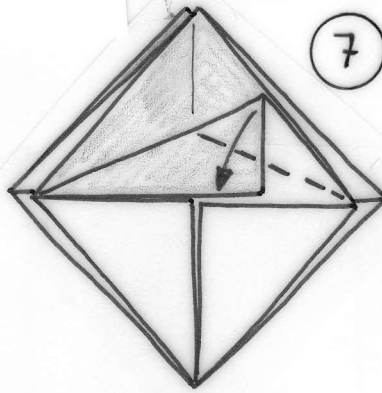
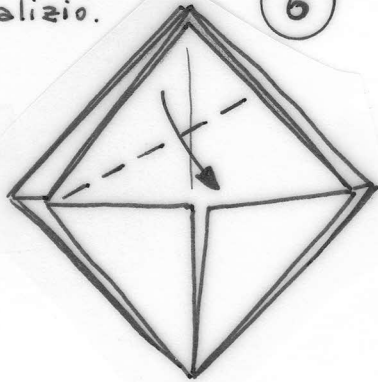

Ripetere i passaggi 6, 7 e 8 sugli altri tre lati e poi aprire le quattro tasche.

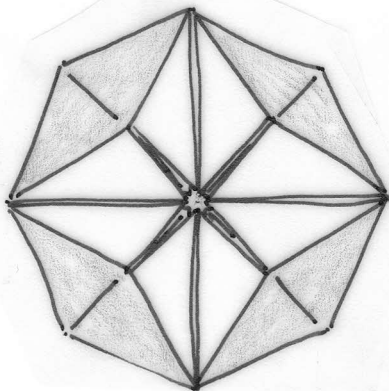
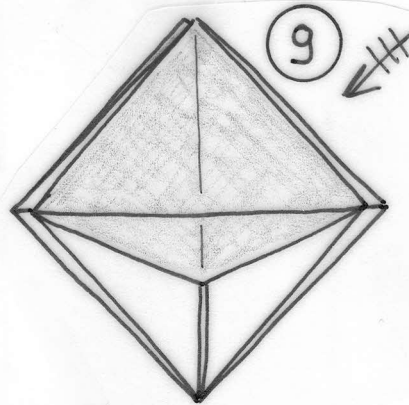

Vista da sotto

10

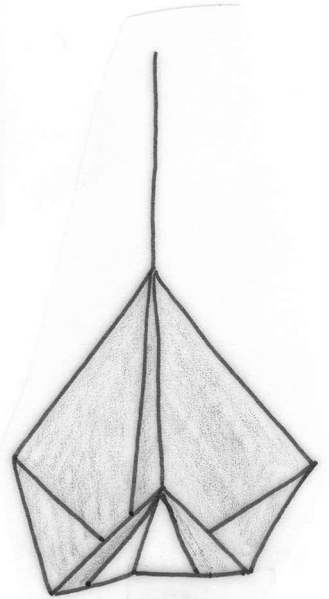

ORNAMENTO NATALIZIO

variante n. 2

Iniziare dal punto 6 dell'ornamento natalizio.

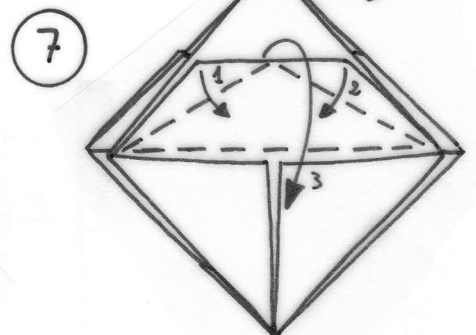
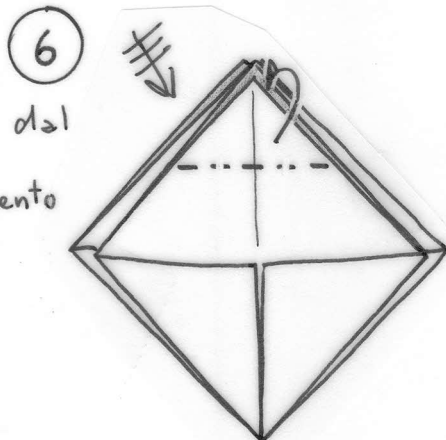

42

8

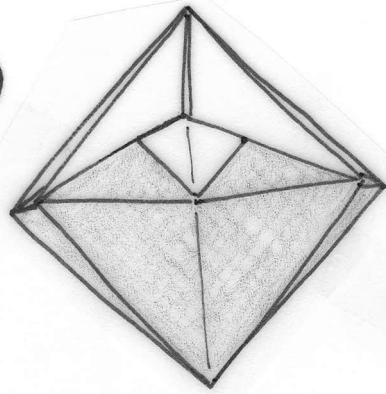

Aprire tutte le quattro tasche.

9

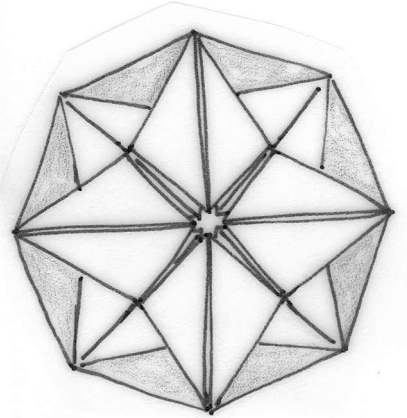

Vista da sotto.

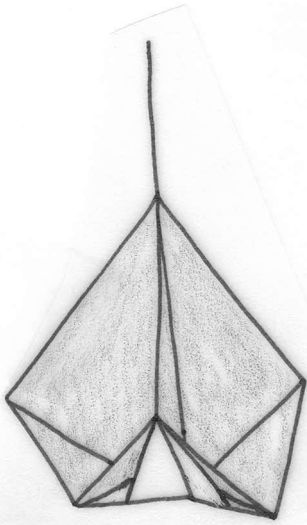

ORNAMENTO NATALIZIO

variante n. 3

8

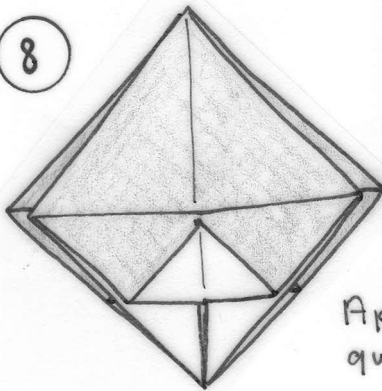

Aprire tutte le quattro tasche.

7

Iniziare dal punto 7 della variante 2

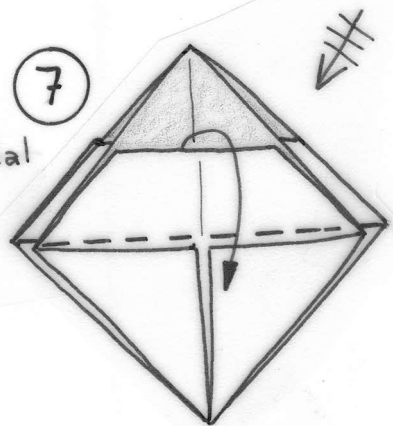

9

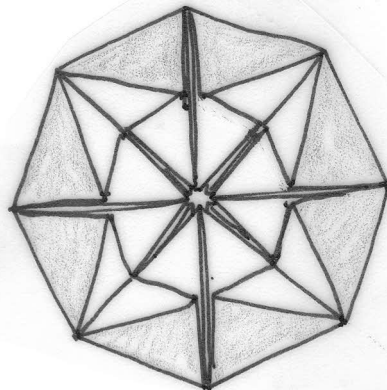

Vista da sotto

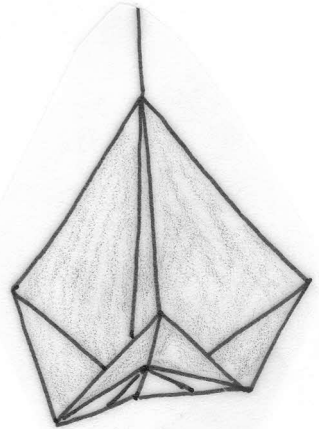

4

ORNAMENTO NATALIZIO

variante n. 4

Iniziare dal punto 6 dell'ornamento natalizio

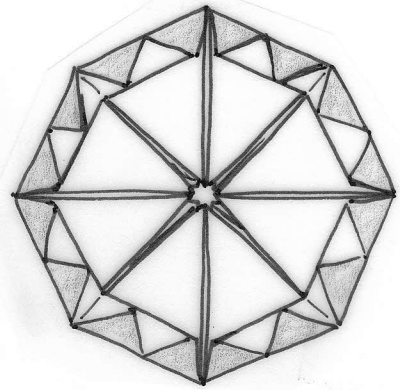
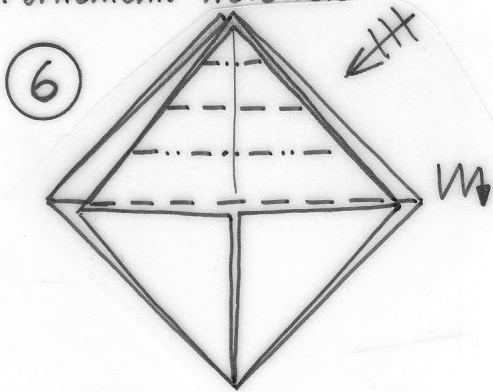

Vista da sotto

ORNAMENTO NATALIZIO

variante n. 5

Iniziare dal punto 7 della variante 4

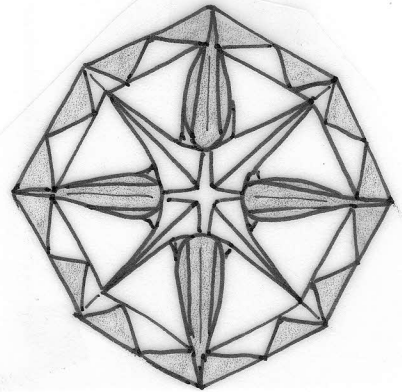
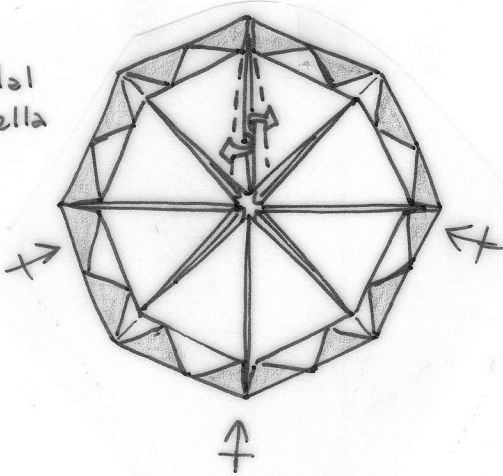

Vista da sotto

ORNAMENTO NATALIZIO

variante n. 6

Iniziare dal punto 4 dell'ornamento natalizio.

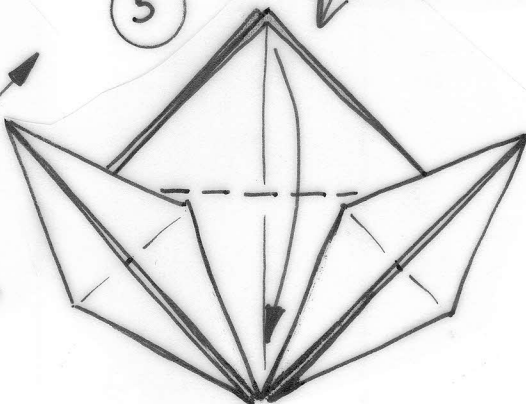
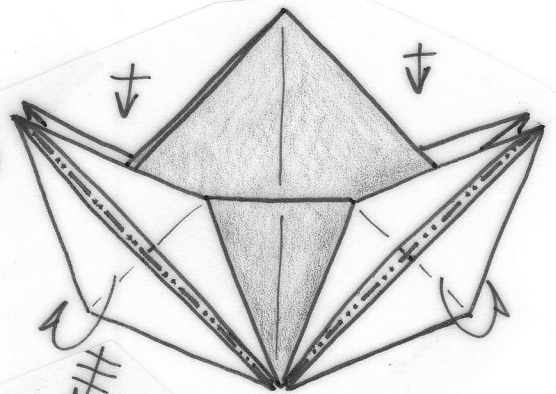
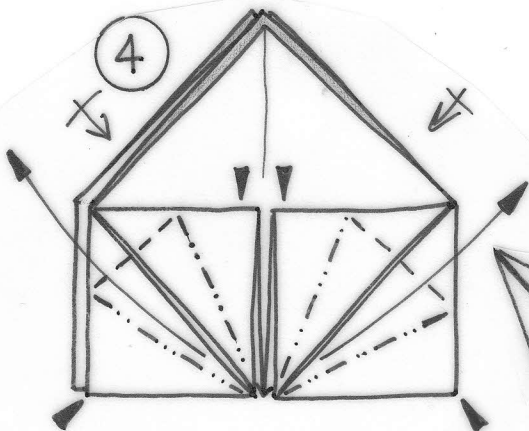

Handwritten signature or mark.

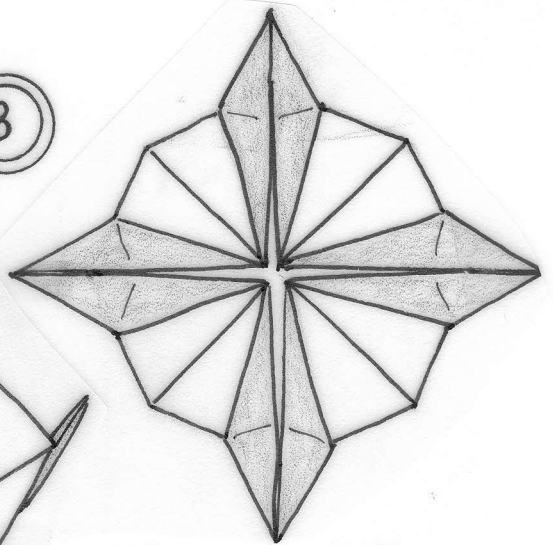
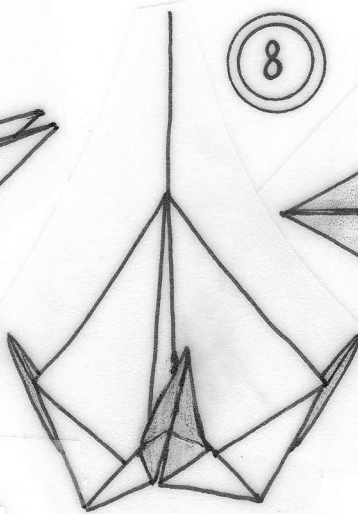
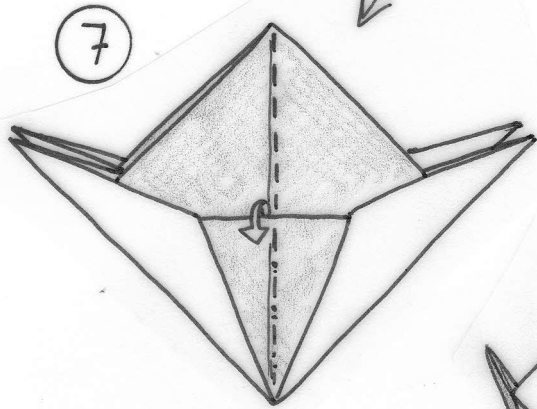

Vista da sotto.

ORNAMENTO NATALIZIO

variante n. 7

Iniziare dal punto 3 dell'ornamento natalizio

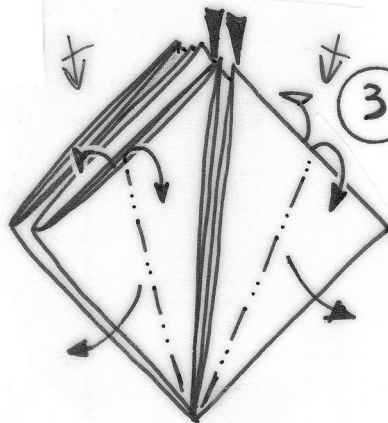

3 Pieghe schiacciate. Vi sono tre strati di carta:



due vanno considerati come foglio unico.

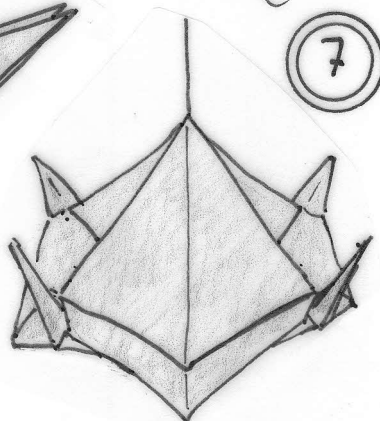
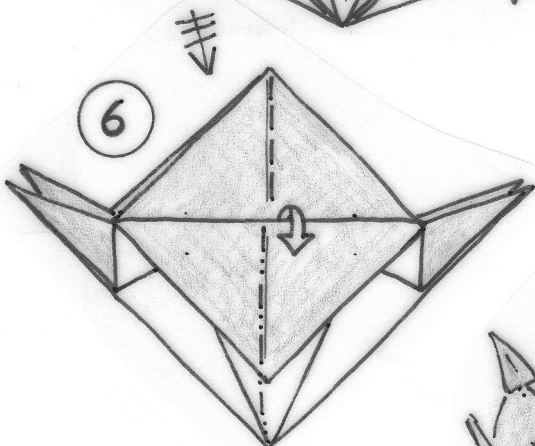
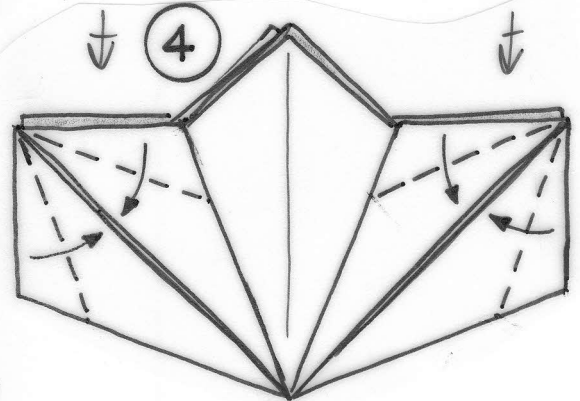
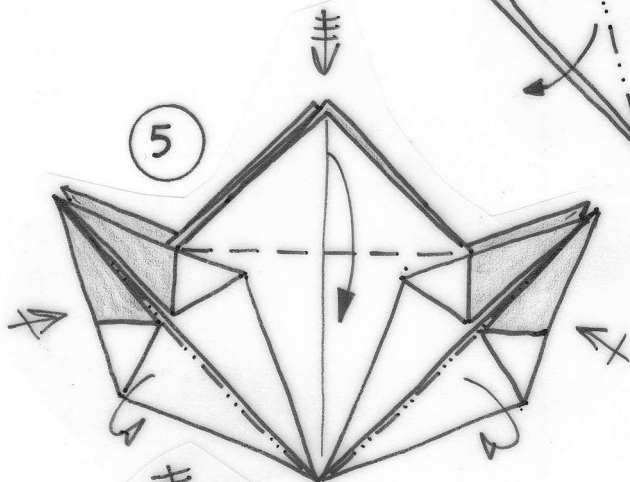

Vista da sotto.

ORNAMENTO NATALIZIO

variante n. 8

Base quadrata

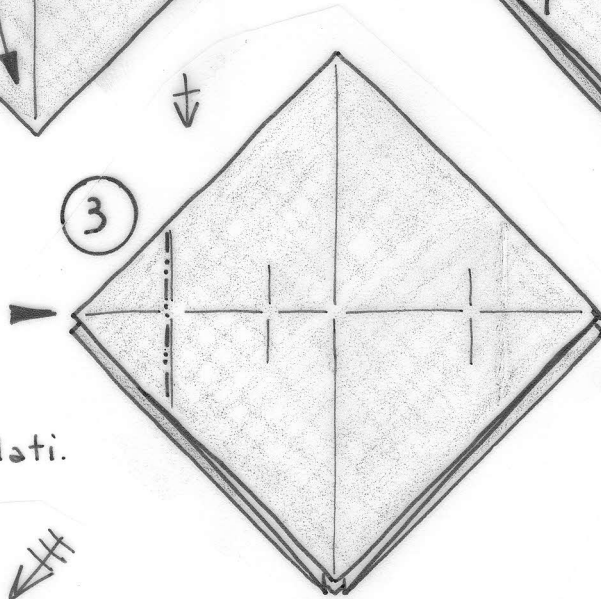
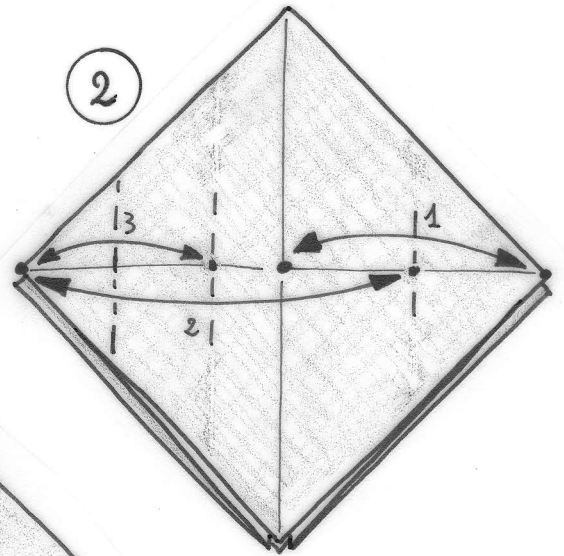
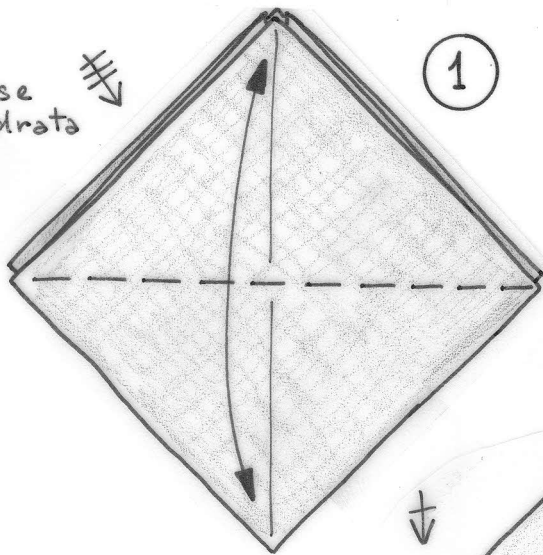

Ripetere i passaggi 2 e 3 sugli altri tre lati.

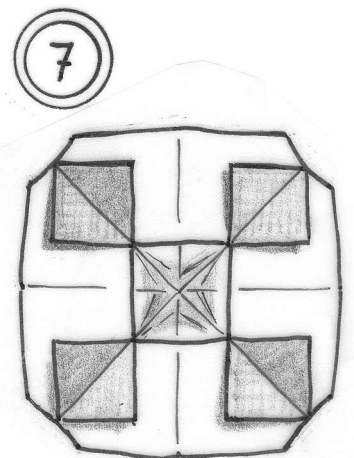
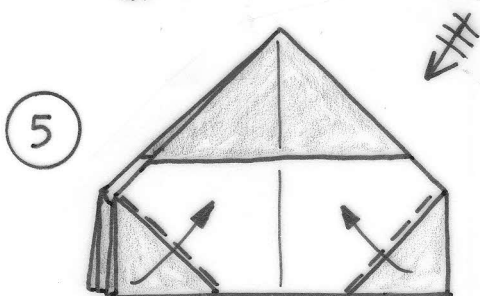
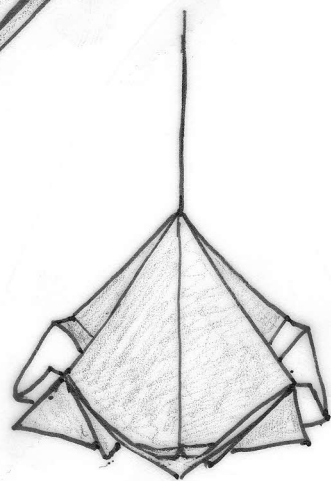
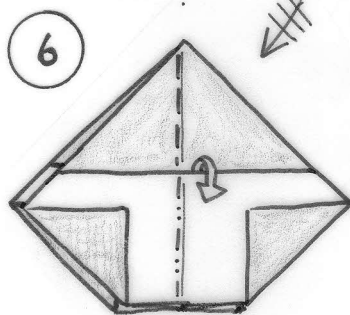
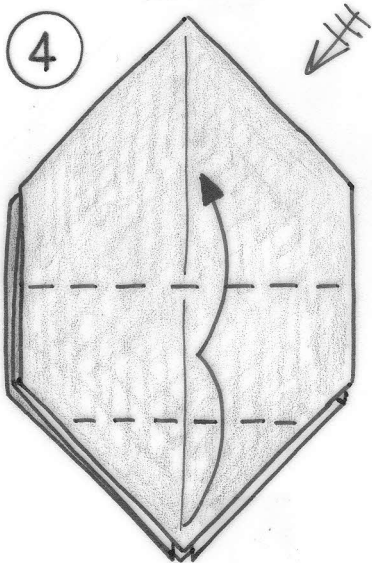

Vista da sotto

LL

ORNAMENTO NATALIZIO

variante n. 9

Iniziare dal punto 4 della variante n. 8.

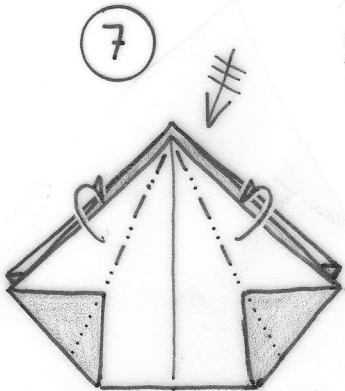
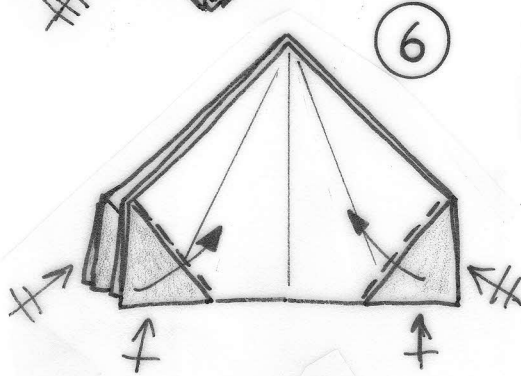
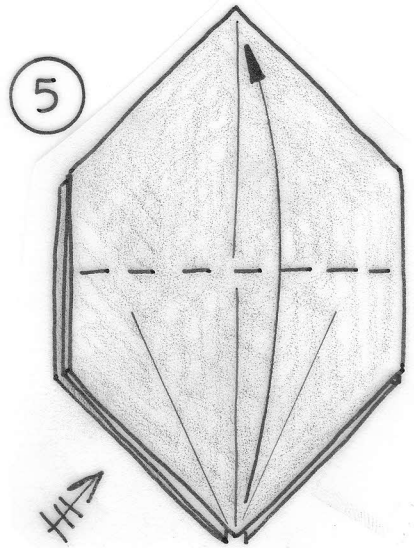
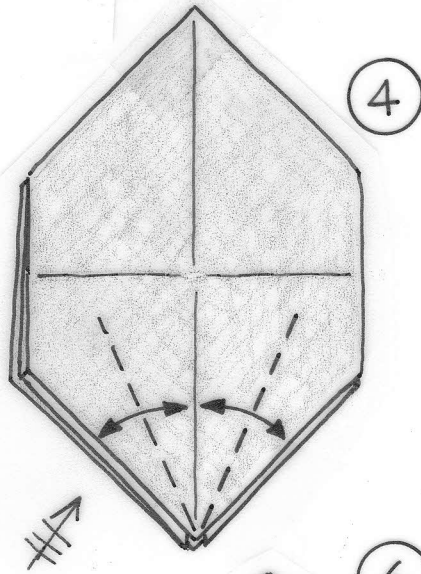

Piegare a monte sulle prepieghe formate al punto 4.

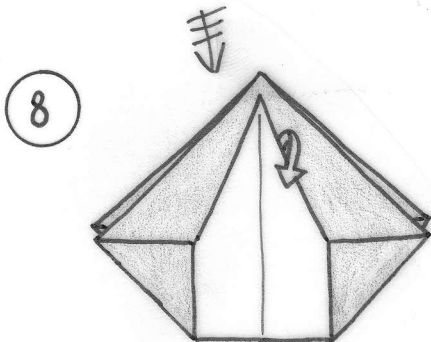
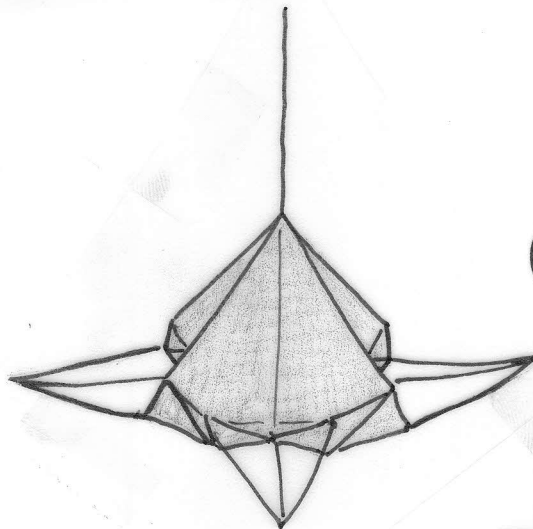

Vista da sotto.

