

PASTORE CHE OFFRE UNA PECORA

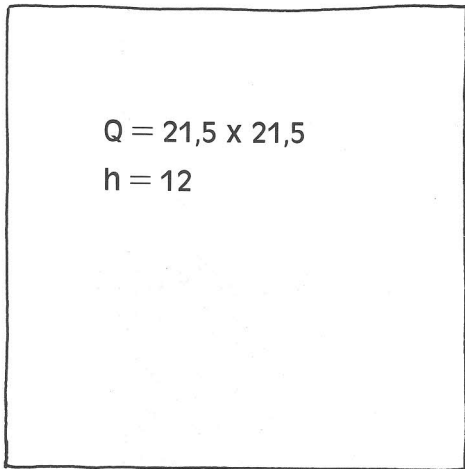

1



BASE DELLA
GRU APERTA

2

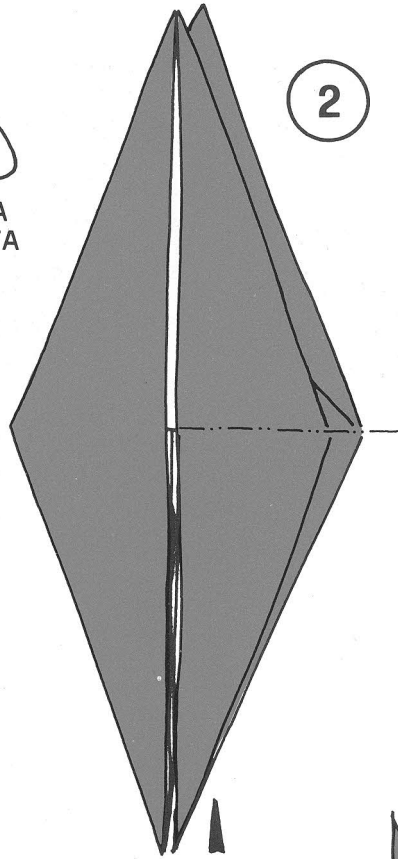

3

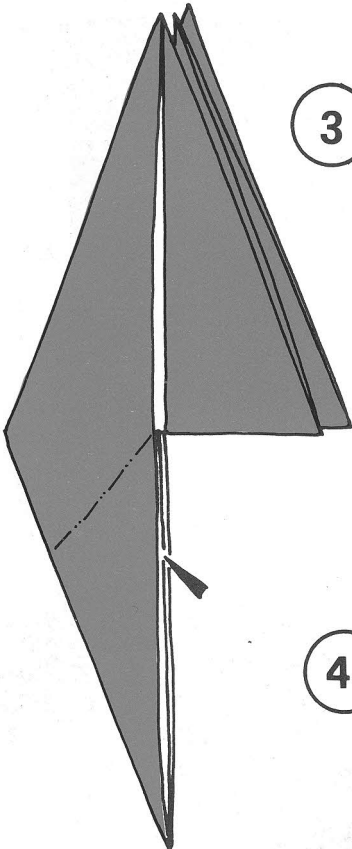

4

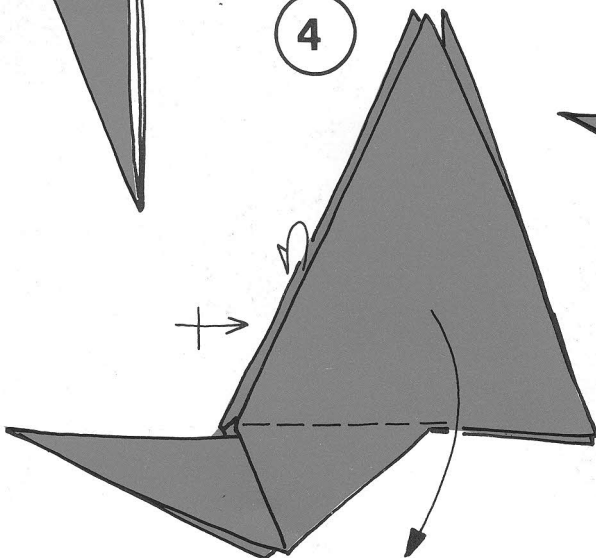

5

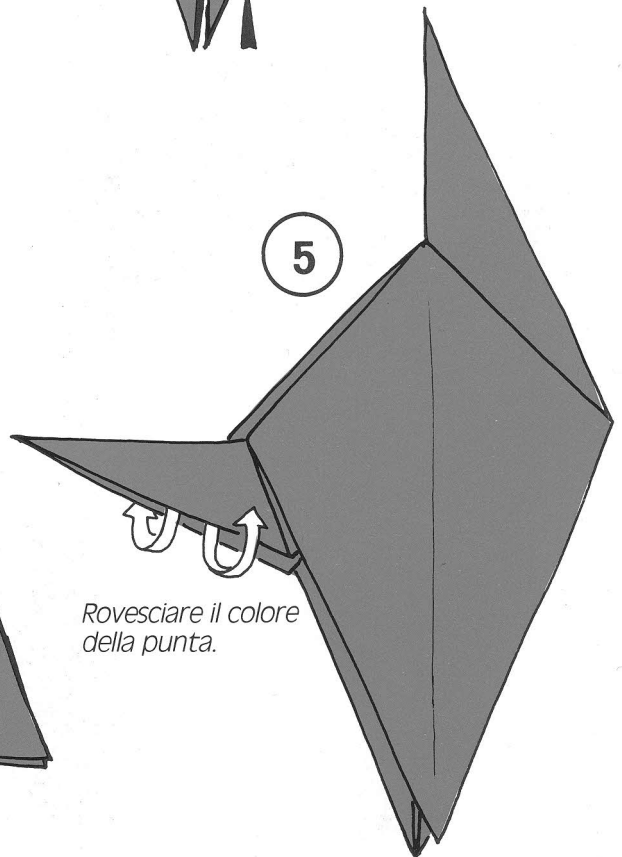

Rovesciare il colore
della punta.

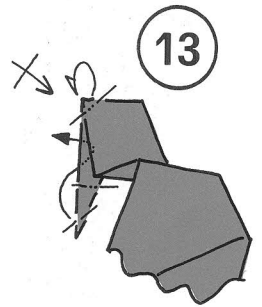
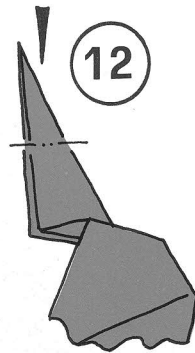
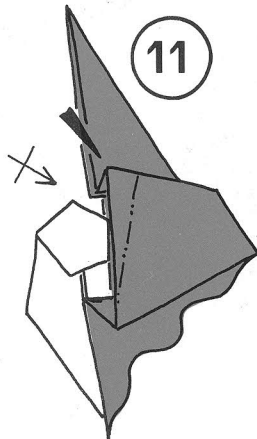
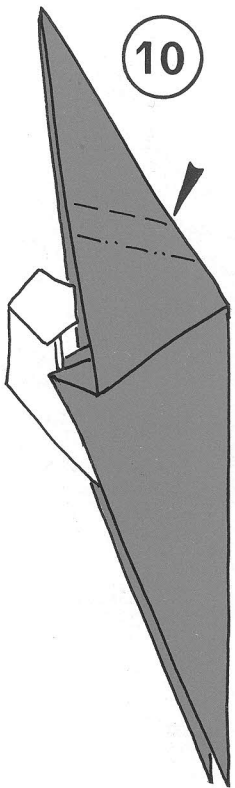
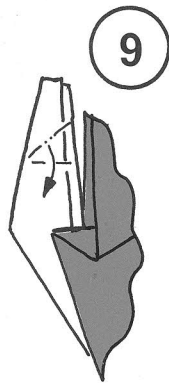
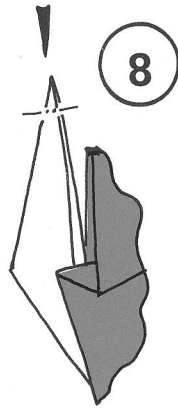
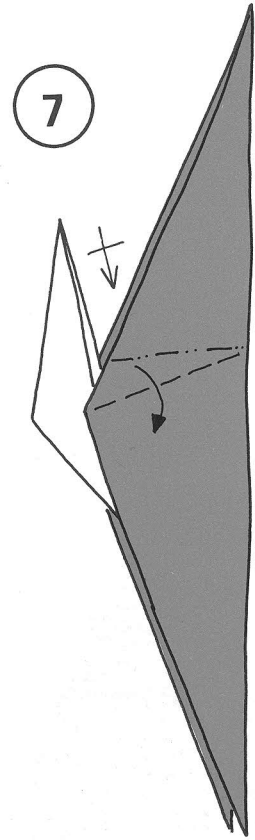
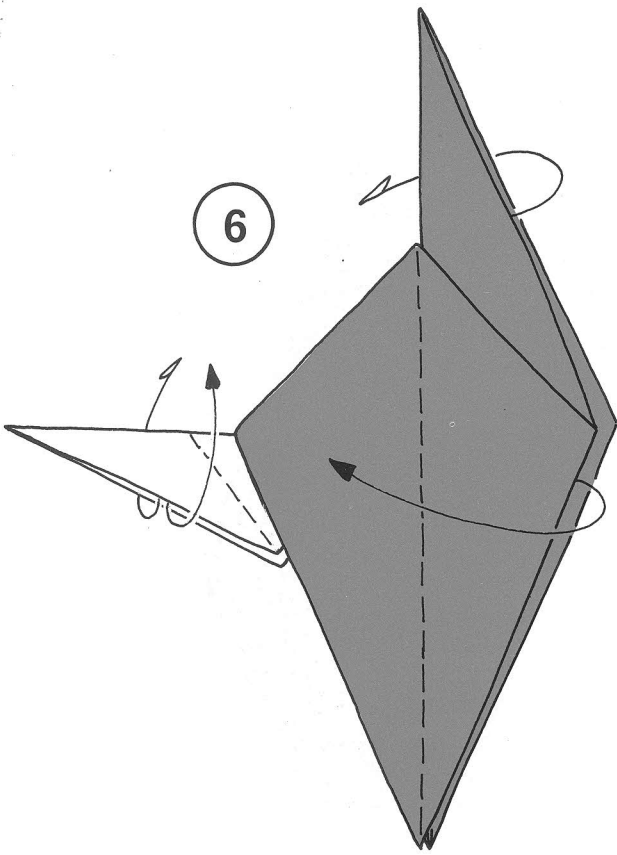

14

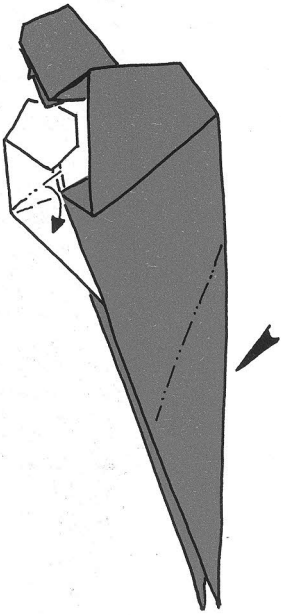

15

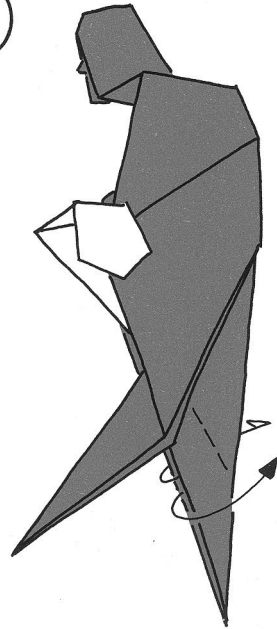

16

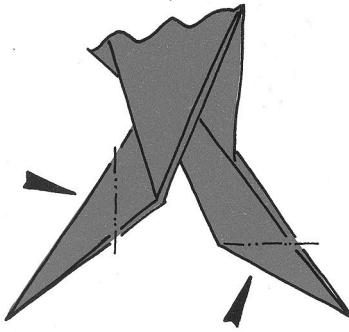

17

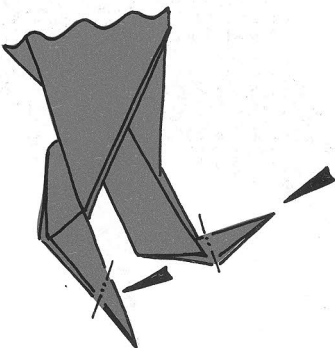

18

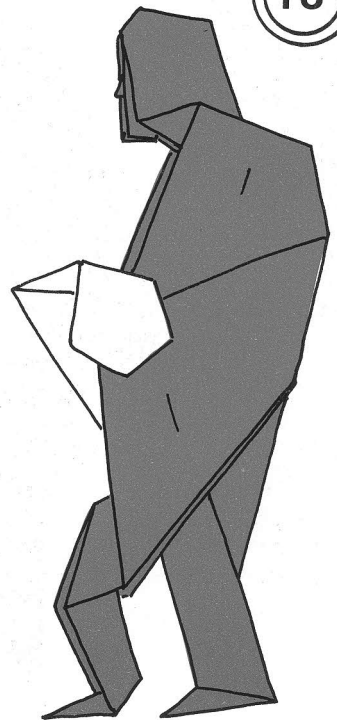

DONNA CHE OFFRE UNA GALLINA

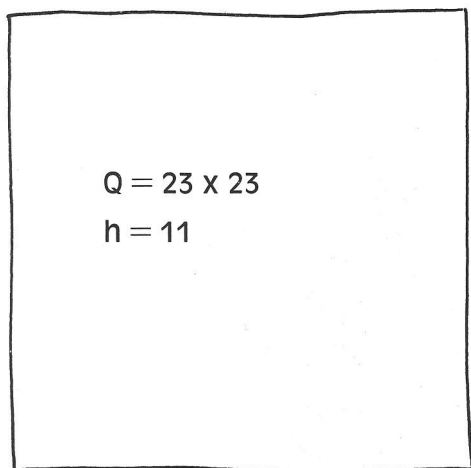

1



BASE DELLA GRU APERTA
con le punte in alto.

2

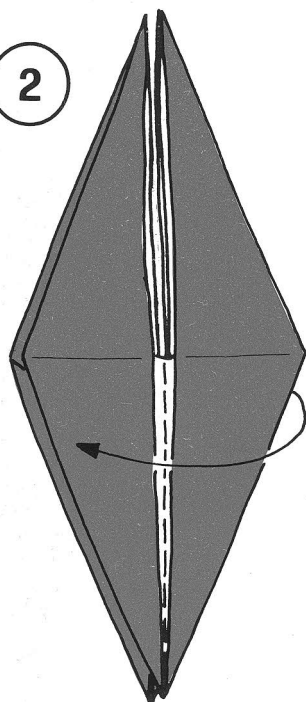

3

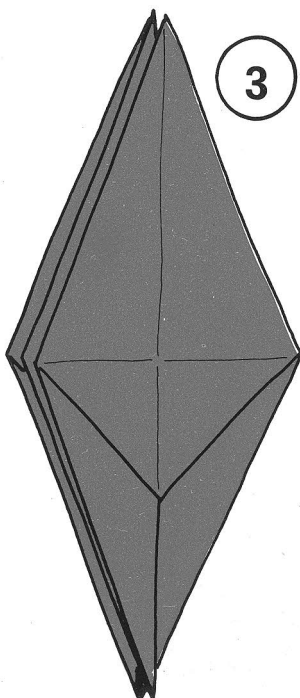

4

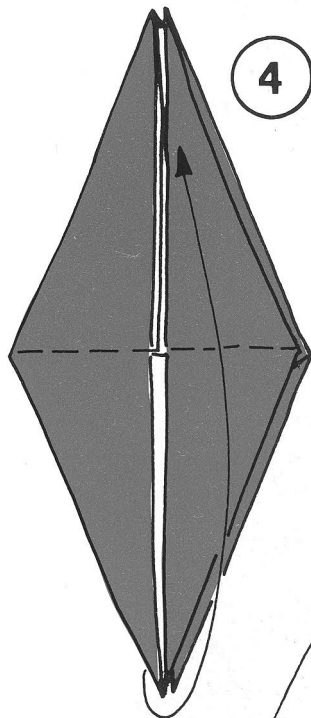

5

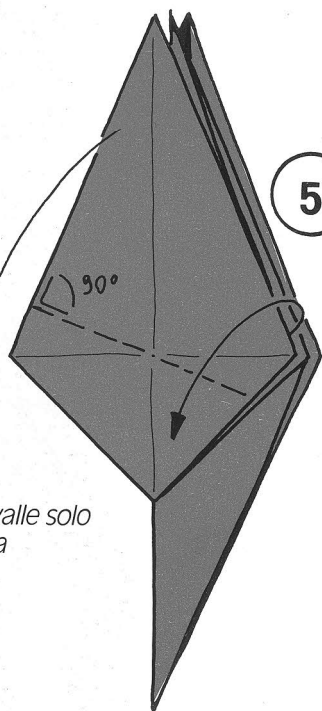

*Piegare a valle solo
la prima ala
davanti e...*

6

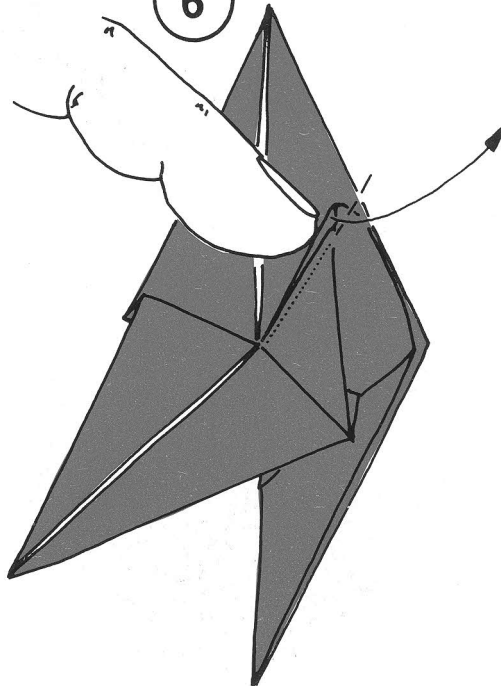

*... appiattare la punta in alto a
destra schiacciandola sul piano del tavolo...*

... così

7

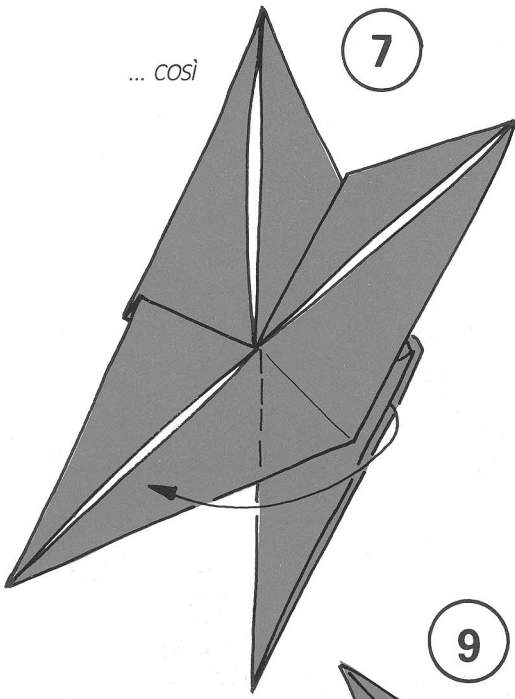

8

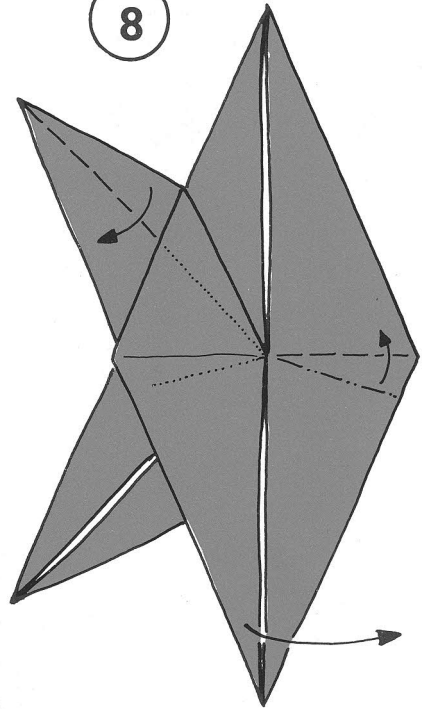

9

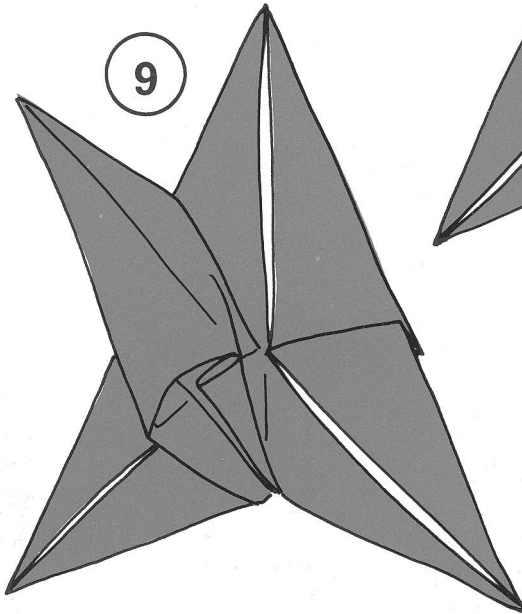

10

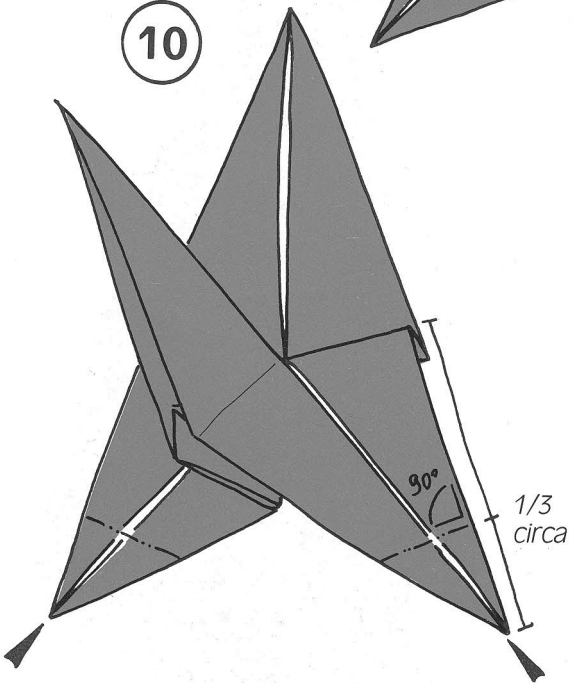

11

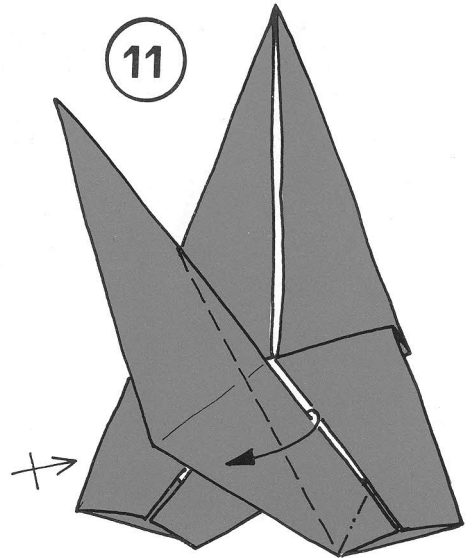

12

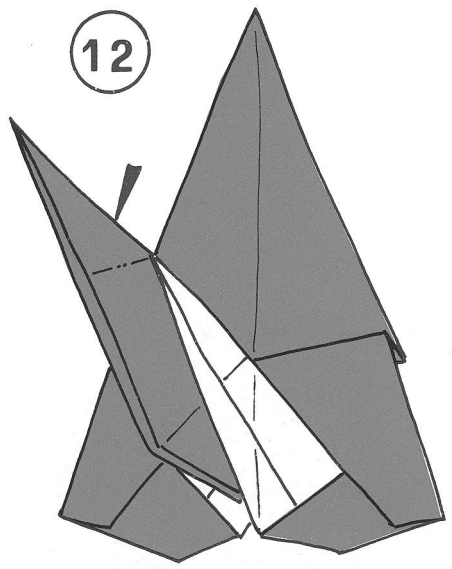

Rovesciare il colore della punta

13

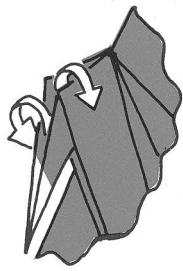

14

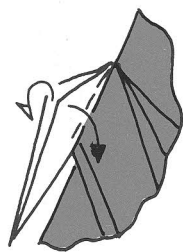

15

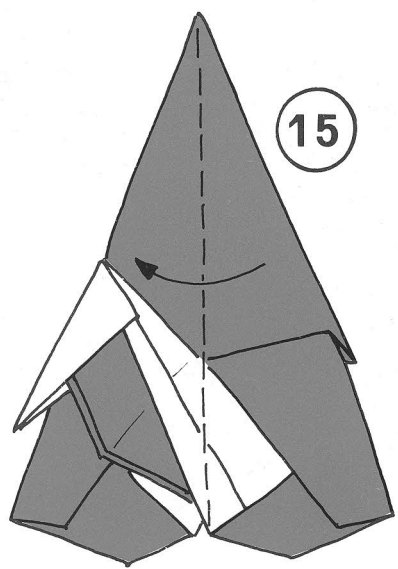

17

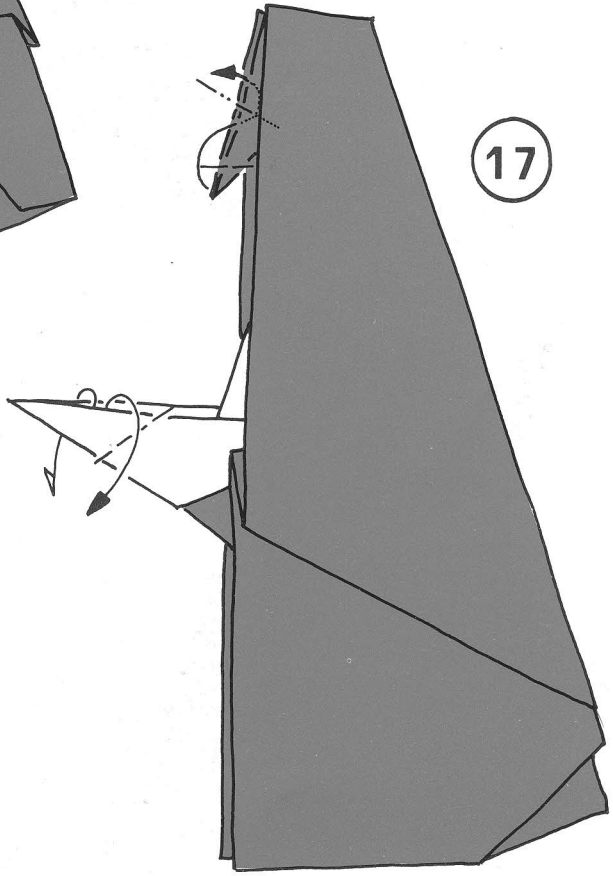

16

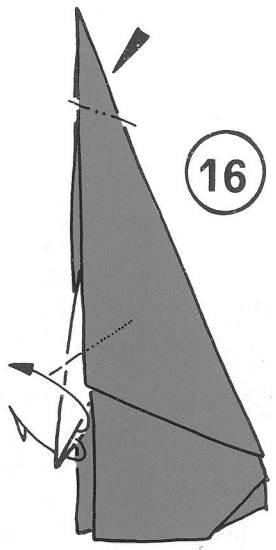

18

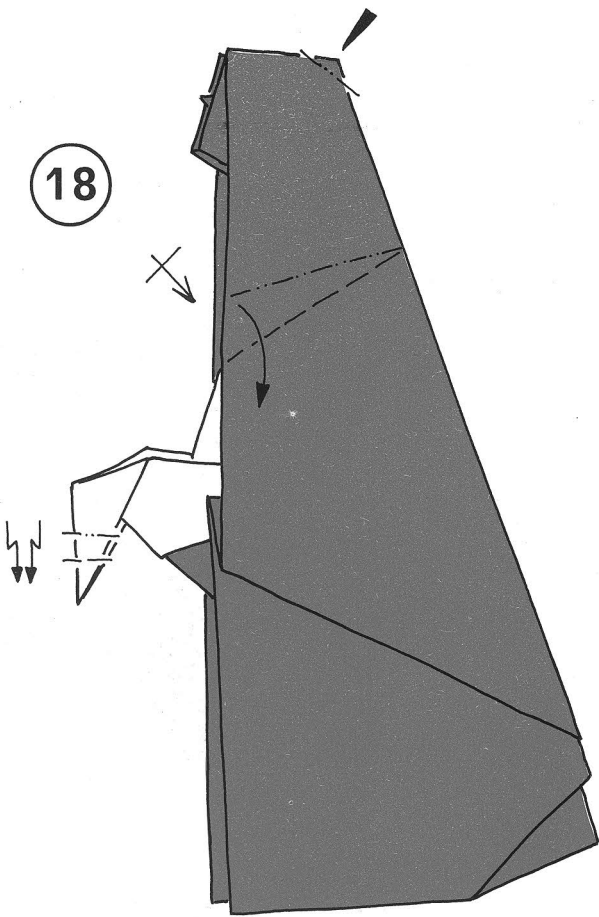

19

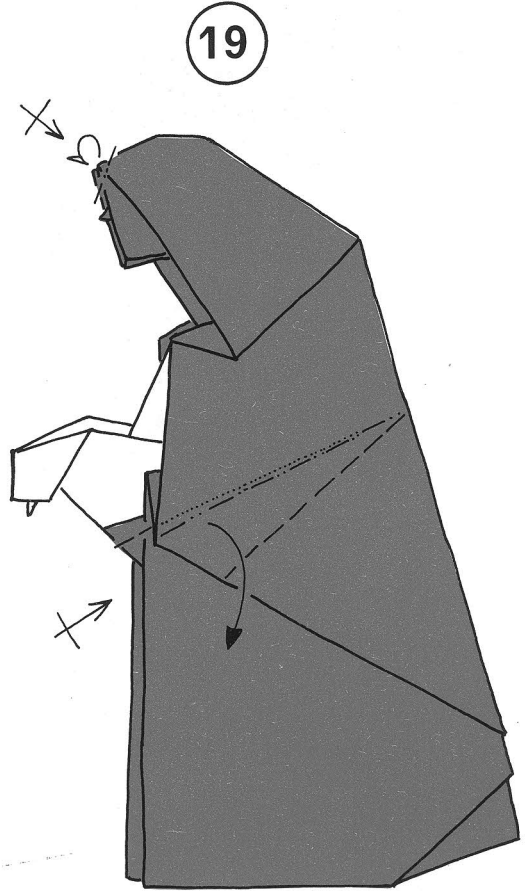

20

