

STALLA

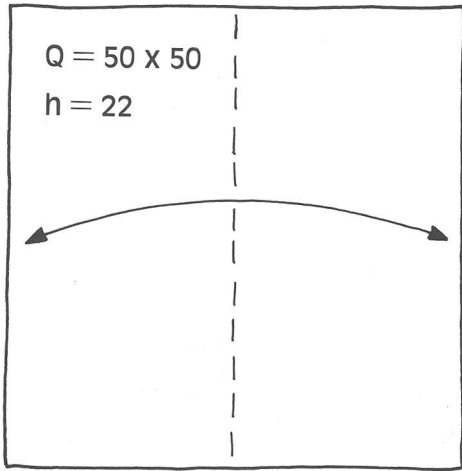

1

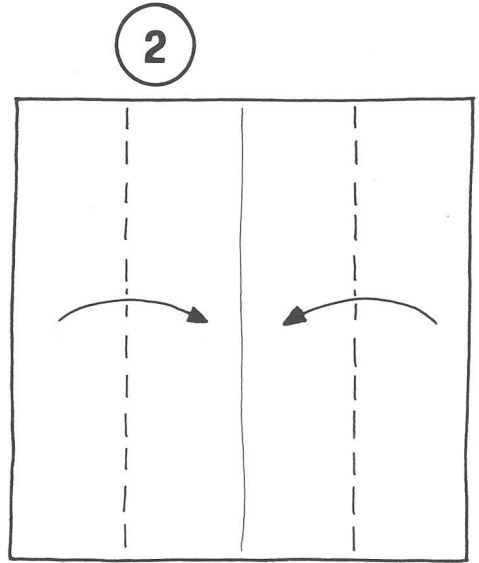

2

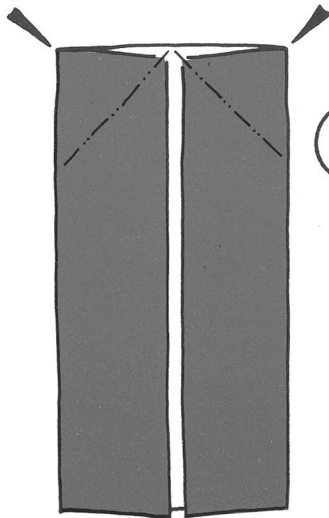

3

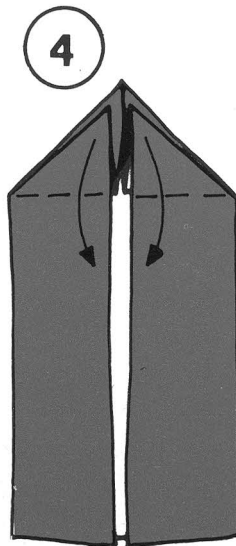

4

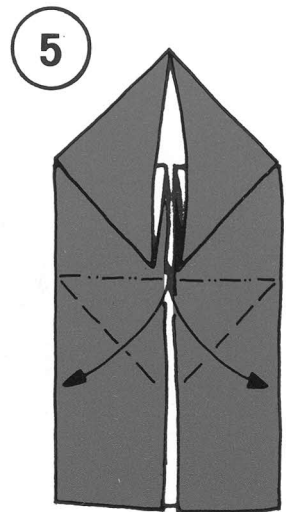

5



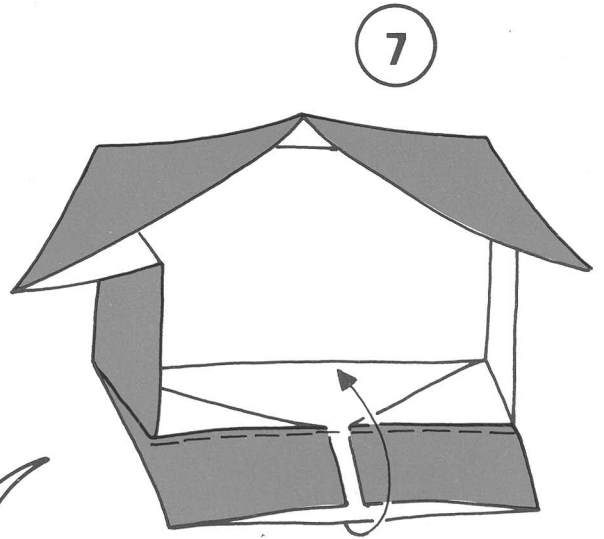
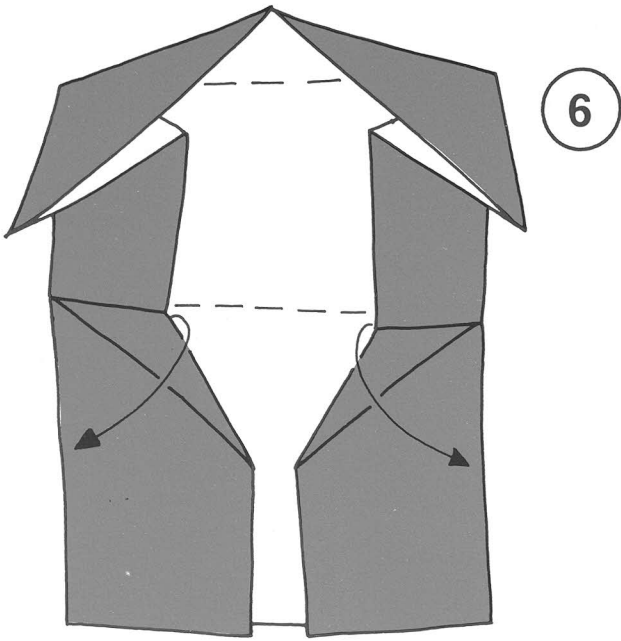

8

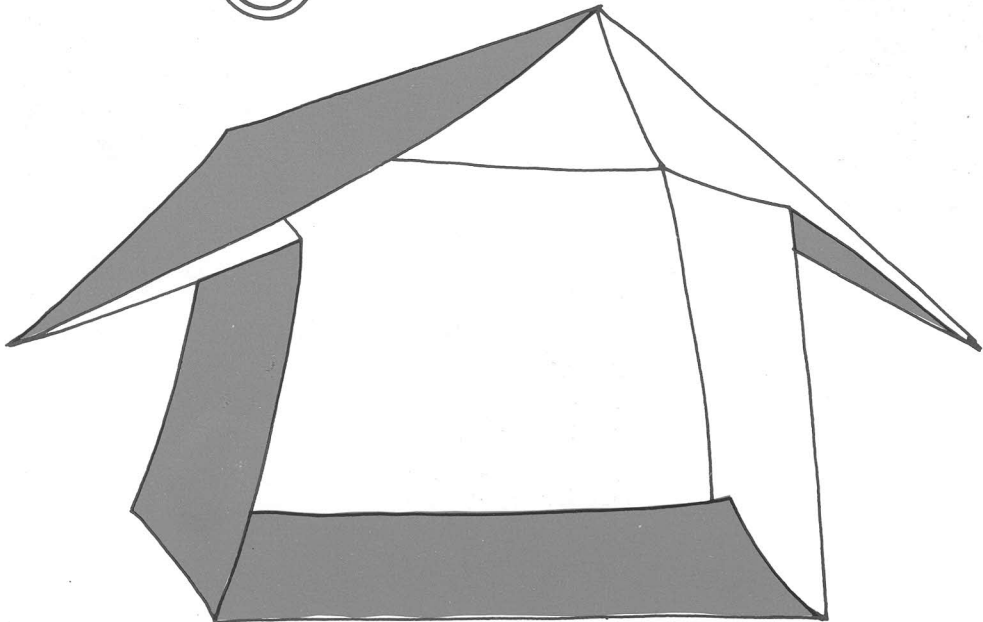

STELLA COMETA

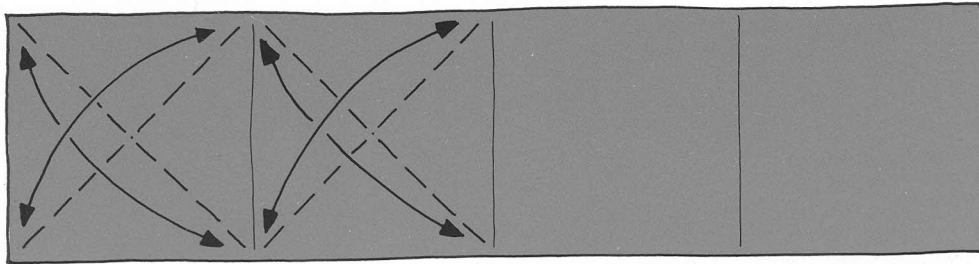

1



2

Iniziare da un rettangolo 1 x 4 e segnare le diagonali dei primi due quadrati.

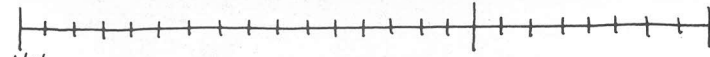
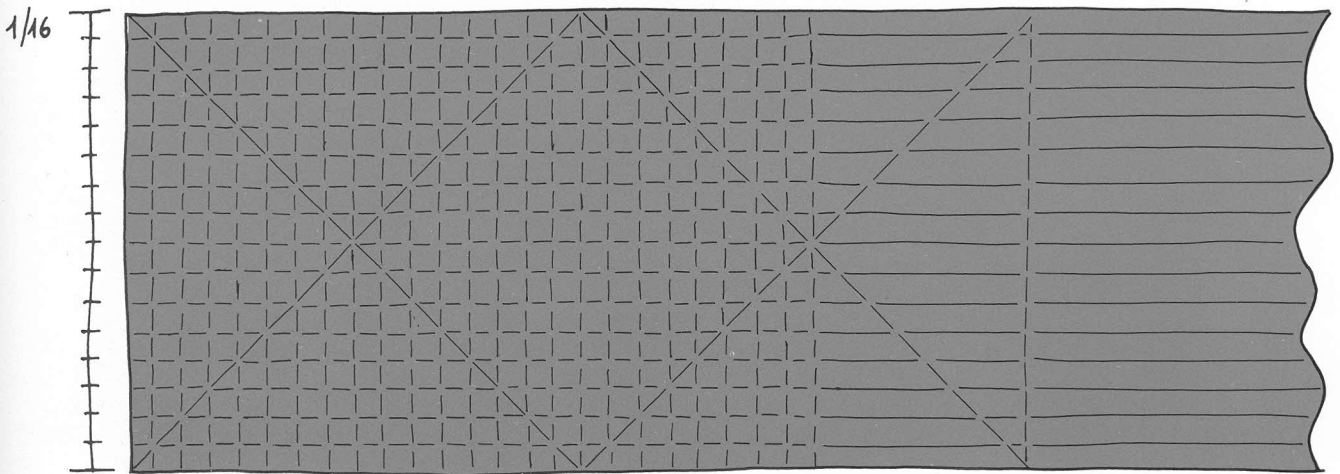

1/16

Dividere il rettangolo in sedicesimi, ma verticalmente, solo fino alla metà del secondo quadrato.

3

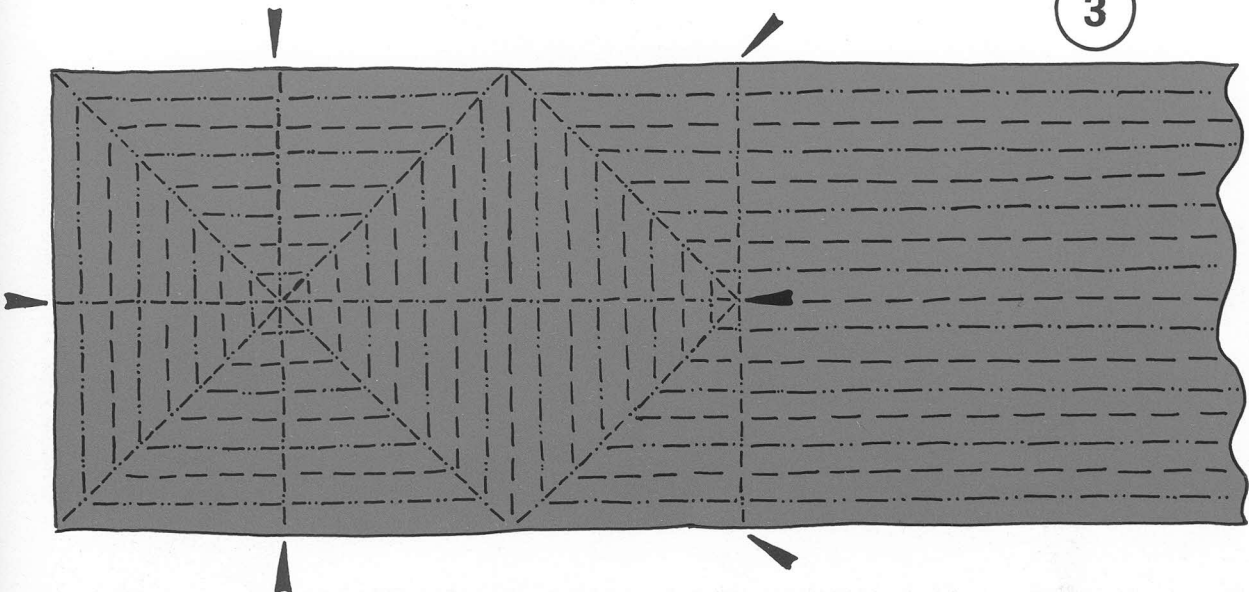

Segnare le pieghe a monte e a valle come indicato e...

... spingere in dentro formando la stella.

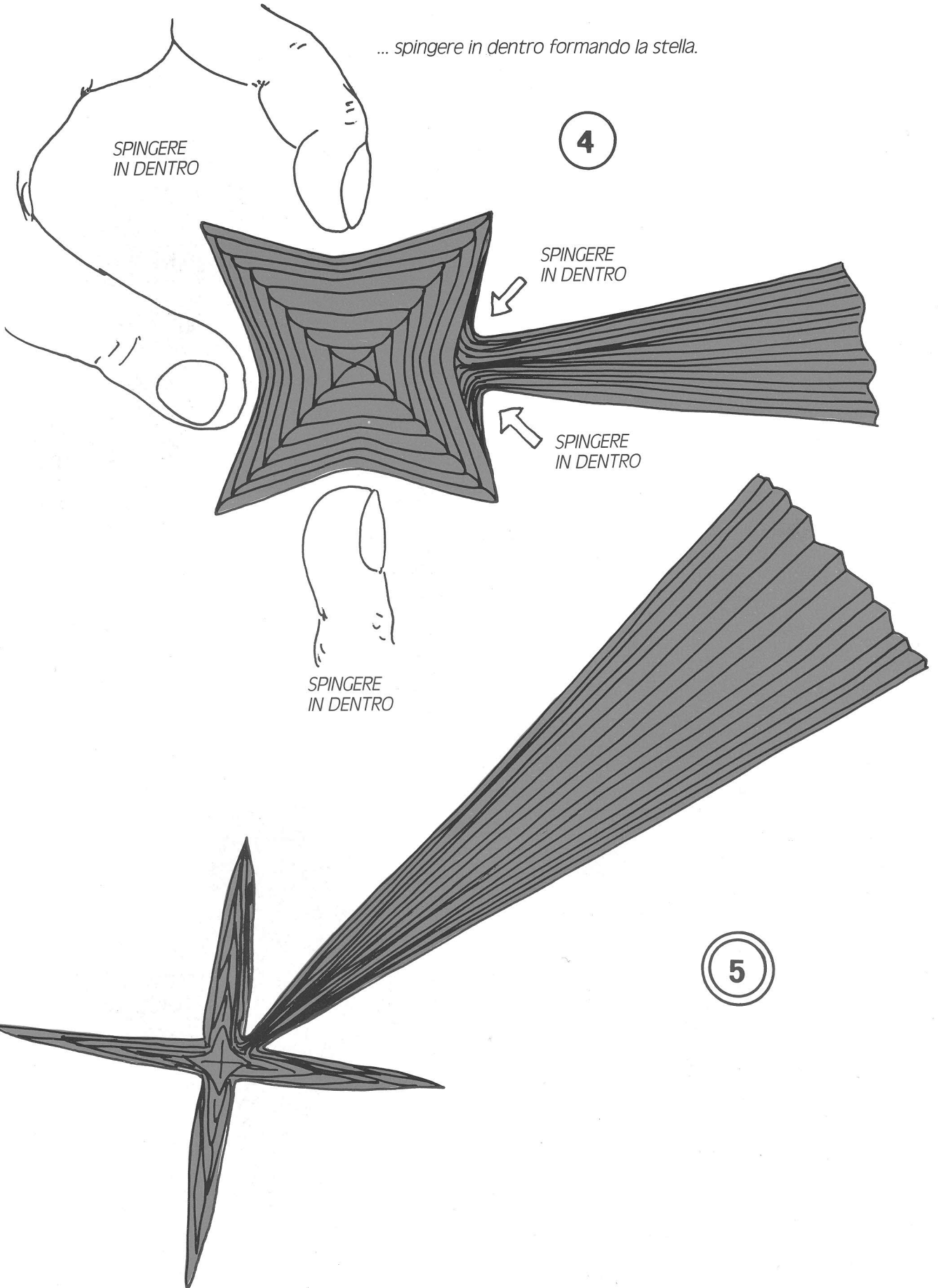

STELLA

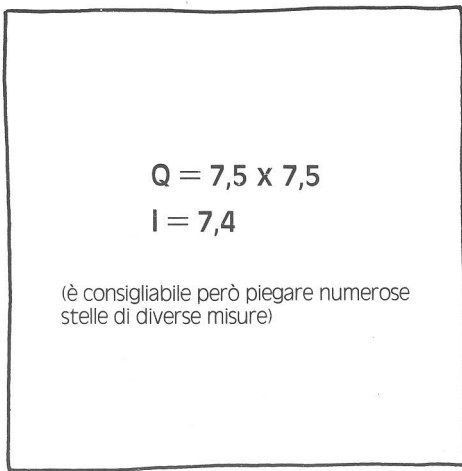

1



BASE DELLA GRU
CHIUSA

2

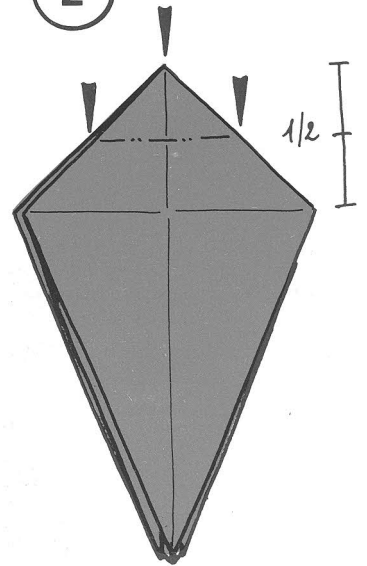

3

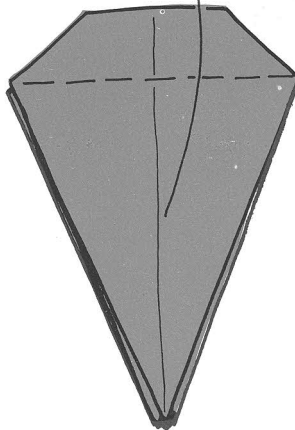

4

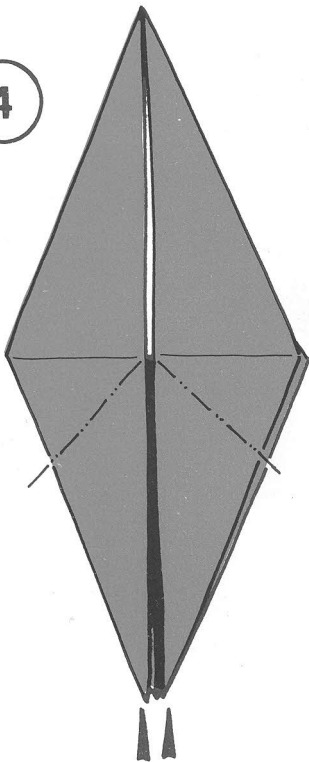

5

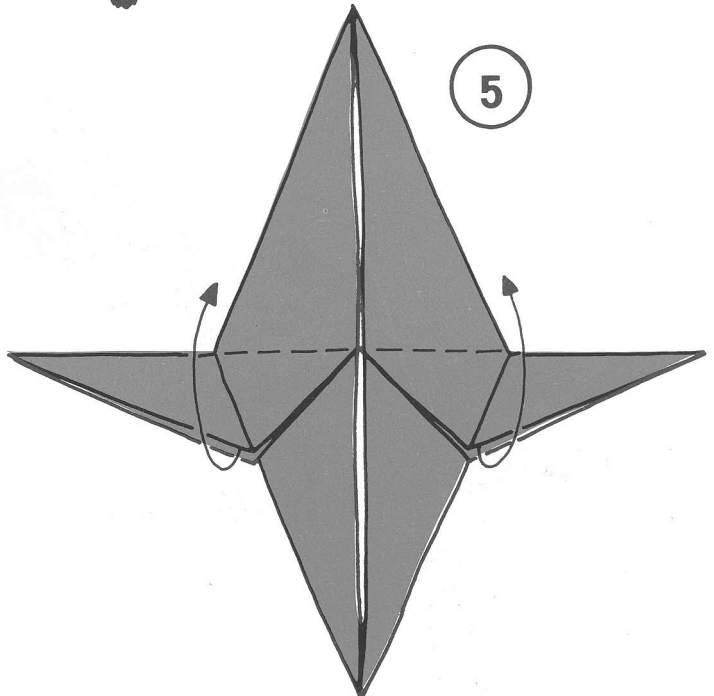

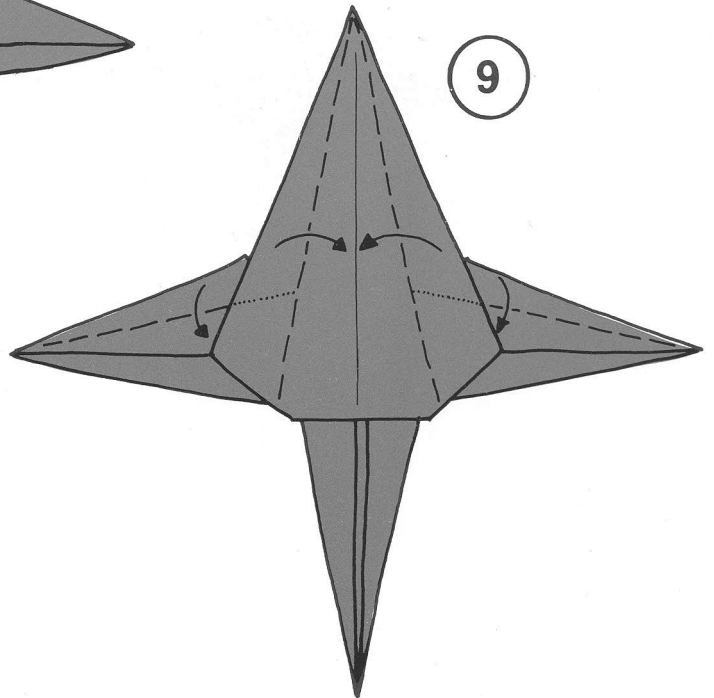
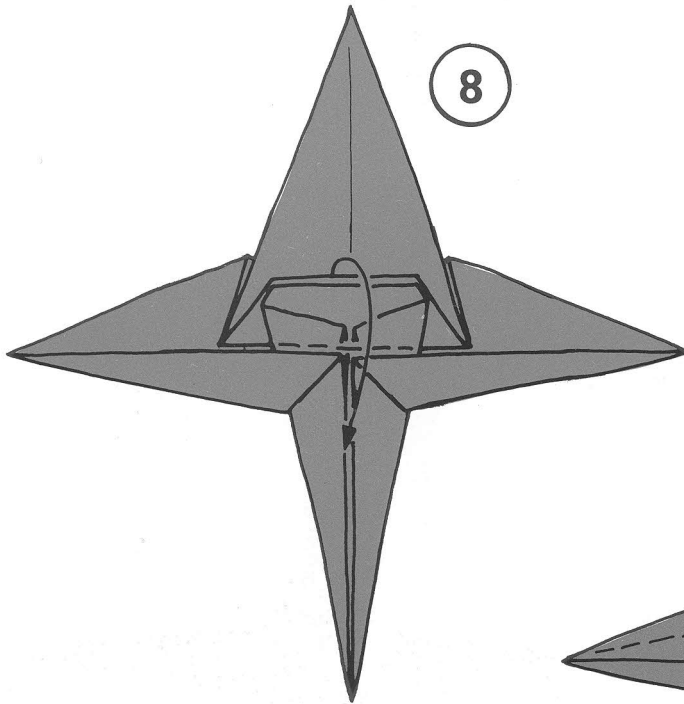
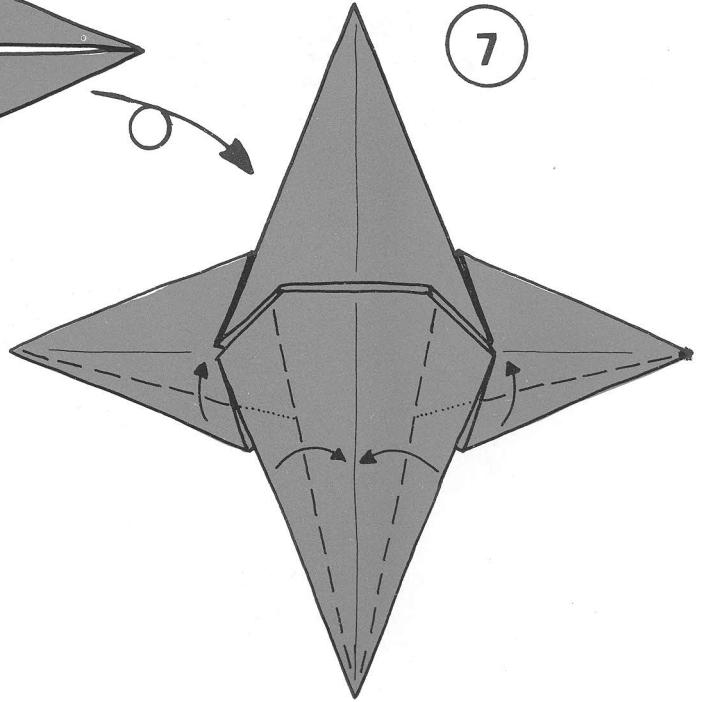
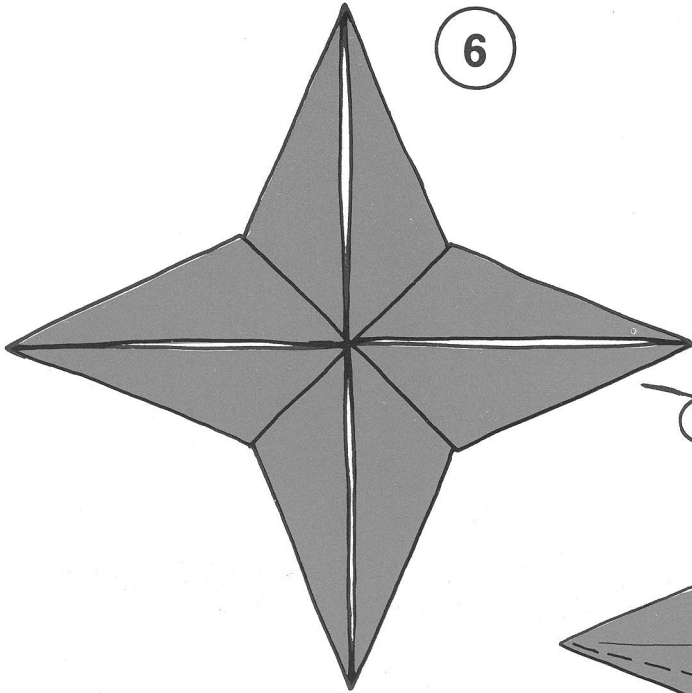

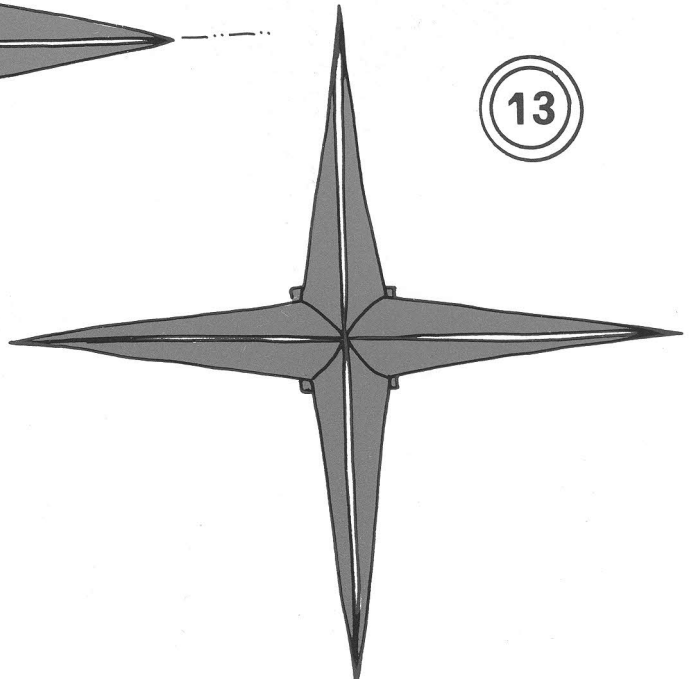
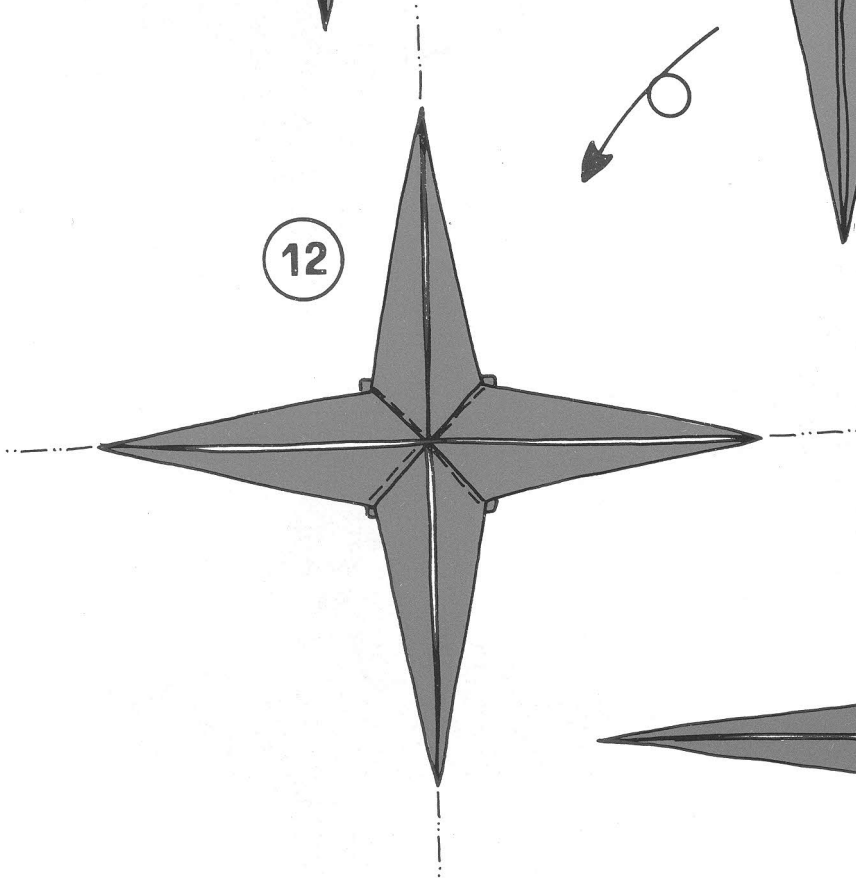
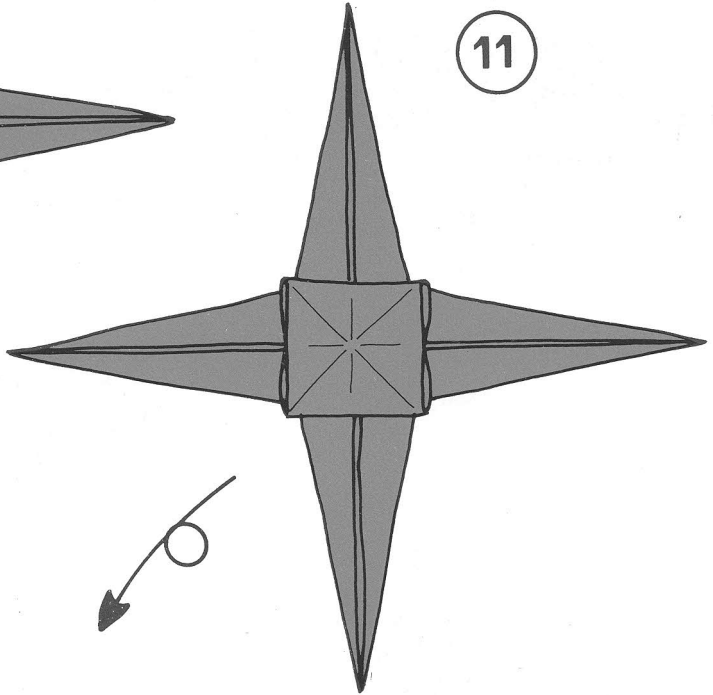
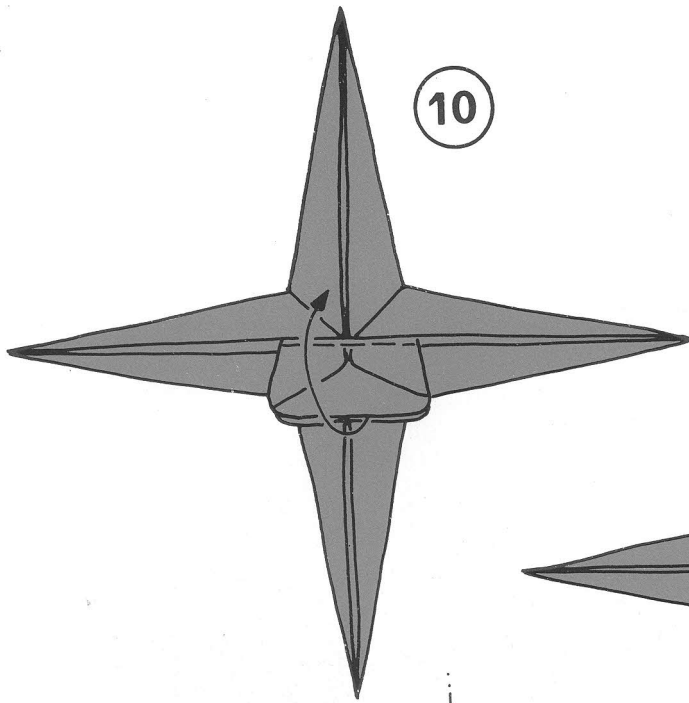

ANGELO

In volo:

$Q = 15,5 \times 15,5$

$h = 11,2$

Inginocchiato:

$Q = 15 \times 15$

$h = 6,5$

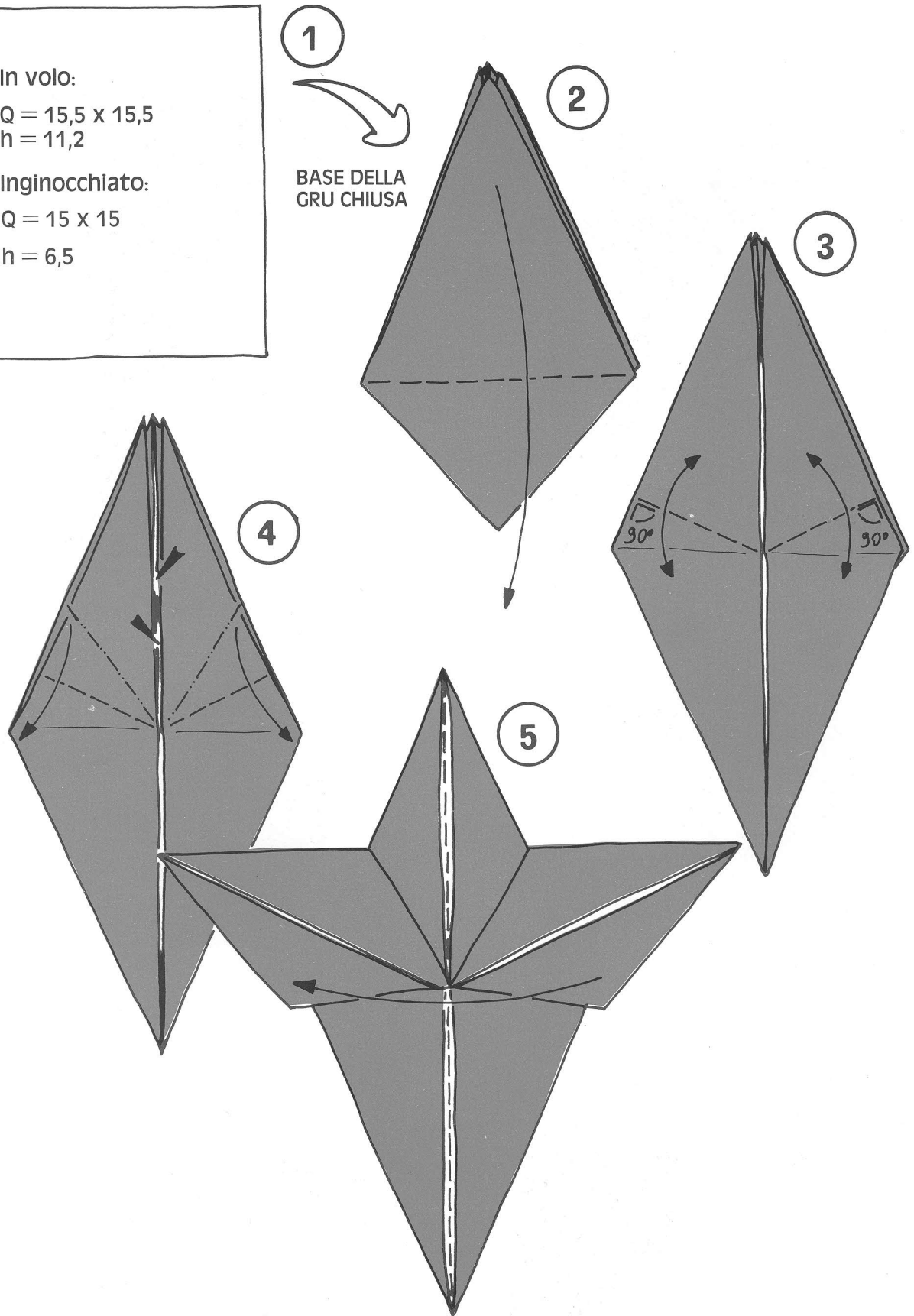

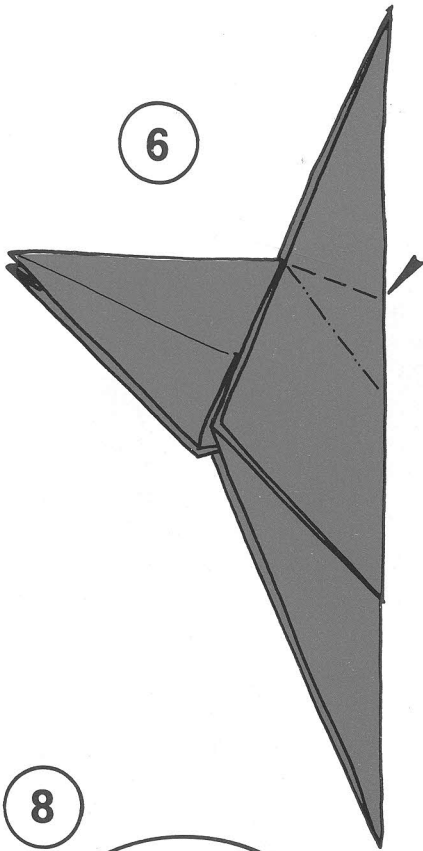

6

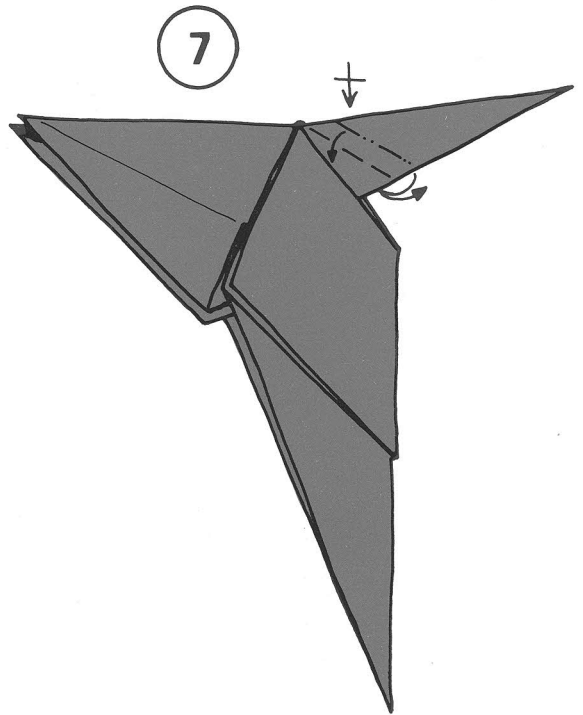

7

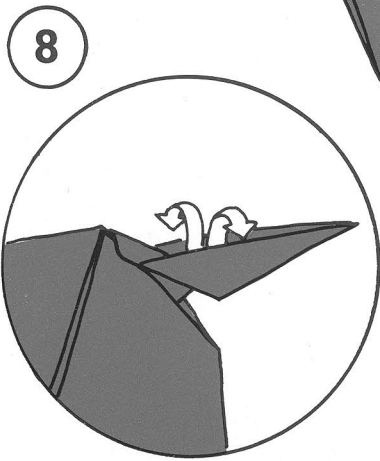

8

Tirare fuori i lembi interni,...

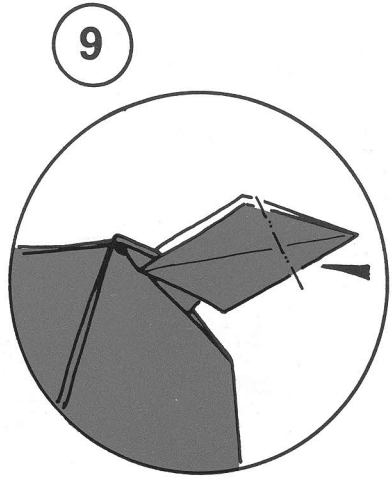

9

... far rientrare la punta...

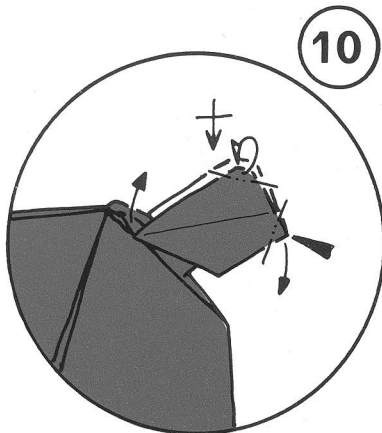

10

... e dare poi forma alla testa, arrotondando gli angoli e abbassandola il più possibile.

11

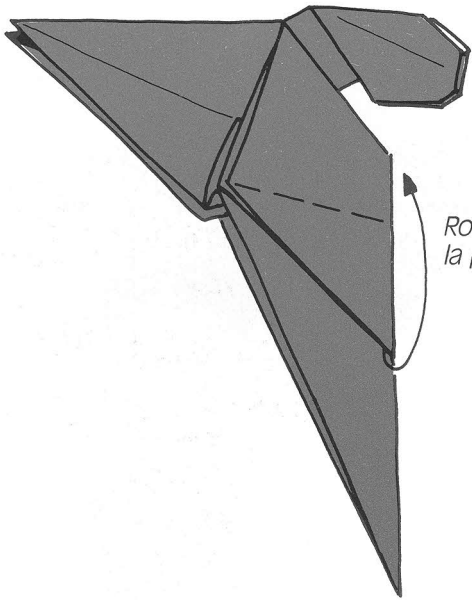

*Rovesciare
la punta*

12

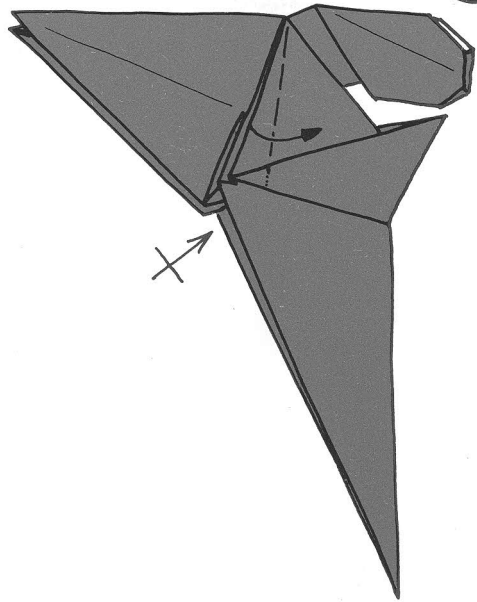

13

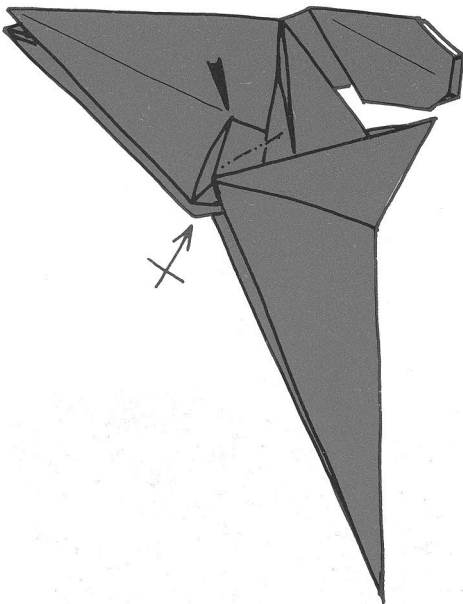

14

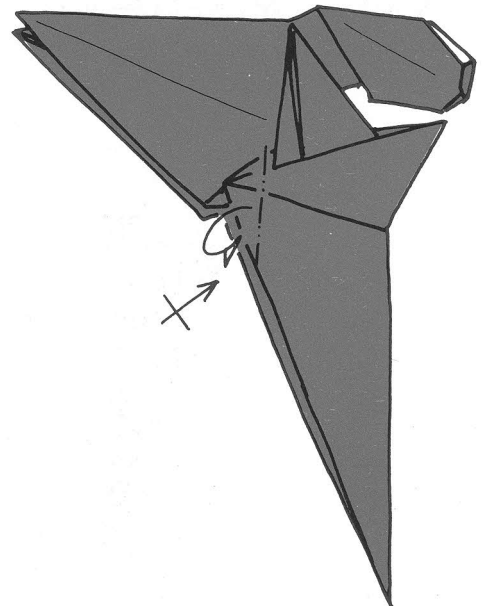

15

*Segnare soltanto
leggermente le pieghe,
allargare la punta e
arrotolarla un poco.*



16



*Si ottiene così
l'ANGELO IN VOLO,
oppure...*

17

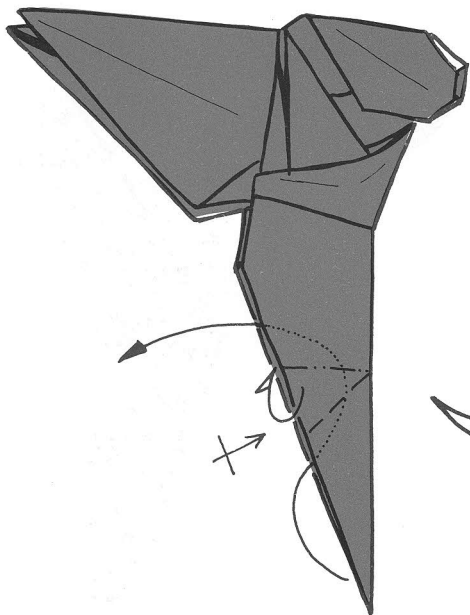

18

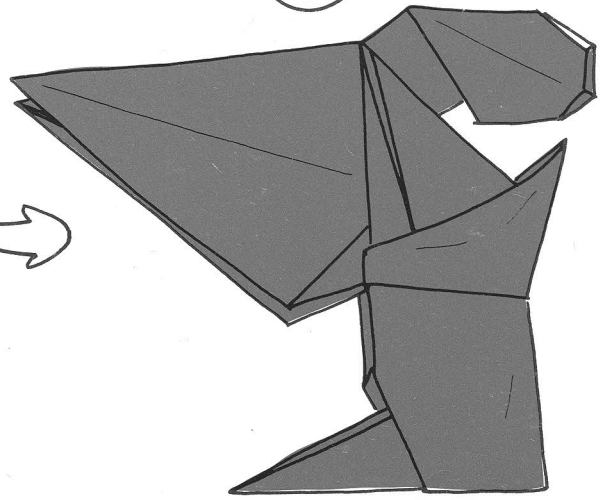

... INGINOCCHIATO